



国晟科技  
Grand Sunergy Tech



# 安装说明书

国晟科技光伏组件

Installation Guide for  
Grand Sunergy Photovoltaic Module

**REGULAR MODULES INSTALLATION MANUAL**  
**常规组件安装手册**

1、INTRODUCTION FOR USER MANUAL 用户手册介绍 .....	- 1 -
1.1、DISCLAIMER 免责声明 .....	- 1 -
1.2、LIMITATION OF LIABILITY 责任范围 .....	- 1 -
2、SAFETY PRECAUTIONS 安全措施 .....	- 1 -
2.1、WARNING 警告 .....	- 1 -
2.2、GENERAL SAFETY 通用安全 .....	- 2 -
2.3、HANDLING SAFETY 操作安全 .....	- 2 -
3、UNLOAD/TRANSPROTATION/STORAGE 卸货、运输和存储 .....	- 4 -
3.1、MAKERS ON OUTER PACKAGING 包装标示说明 .....	- 5 -
3.2、UNLOADING WARNNING 卸货注意事项 .....	- 6 -
3.3、SECONDARY TRANSPORT AND WARNING 二次运输及注意事项 .....	- 7 -
3.4、STORAGE 存储 .....	- 8 -
3.5、Working Conditions 工作条件 .....	- 8 -
3.6、Junction box connector and bypass diode 接线盒连接器和旁路二极管 .....	- 9 -
3.7、ELECTRICAL RATING 额定功率 .....	- 9 -
4.UNPACKING SAFETY 拆包安全 .....	- 21 -
5、INSTALLATION 安装 .....	- 23 -
5.1、INSTALLATION SAFETY 安装安全 .....	- 23 -
5.2、ENVIRONMENT CONDITIONS AND SITE SELECTION 环境条件与安装地址选择 .....	- 24 -
5.3、TILT ANGLE OF INSTALLATION 光伏组件安装倾角 .....	- 26 -
5.4、INSTALLATION REQUIREMENTS FOR BIFACIAL CELLS MODULE 双面电池组件安装要求 .....	- 27 -
5.5、INSTALLATION METHOD 安装方法 .....	- 28 -
6、FIRE SAFETY 防火安全 .....	- 41 -
7、MODULE MAINTENANCE 组件维护 .....	- 41 -
7.1、PANEL VISUAL INSPECTION AND REPLACEMENT 组件外观检查和替换 .....	- 42 -
7.2、CONNECTOR AND CABLE INSPECTION 连接器和线缆检查 .....	- 43 -
7.3、CLEANING 清洗 .....	- 43 -

## 1、INTRODUCTION FOR USER MANUAL 用户手册介绍

This general manual applies to the installation, maintenance and use of the single glass Solar modules manufactured by Guosheng Shian Technology Co., Ltd. (hereinafter referred to as "Grand Sunergy"). Failure to follow these instructions could result in personal injury or property damage.

本手册适用于国晟世安科技股份有限公司 (以下简称国晟科技) 生产的所有系列太阳能组件的安装、维护和使用。如果不遵守, 将可能导致人员伤亡或财产损失。

Installation and operation of PV modules requires professional skills and should only be performed by qualified professionals. Please read the "Safety and Installation Instructions" carefully before using and operating the modules.

光伏组件的安装和操作需要专业技能, 只能由合格的专业人员执行。在使用和操作组件之前, 请仔细阅读“安全和安装说明”。

The word " module" or " PV module" used in this manual refers to one or more Solar modules. Please keep this manual for future reference.

本手册中的“组件”或“PV组件”指的是一个或多个太阳能组件。请保留此说明书以供将来参考。

### 1.1、DISCLAIMER 免责声明

1、Guosheng Shian Technology Co., Ltd. reserves the rights to change this User Manual without prior notice.

国晟世安科技股份有限公司保留在没有预先通知的情况下变更本安装手册的权利。

2、In the event of any inconsistency among different language versions of this document, the English version shall prevail.

如果本手册的不同语言版本有描述不一致的情况, 以英文版为准。

3、Failure of the customer to follow the requirements outlined in this Manual during the installation of the module will result in the invalidity of product's limited warranty.

客户在安装组件过程中未按照本手册中所列出的要求操作, 会导致提供给客户的产品有限质保失效。

4、Grand Sunergy is not responsible for any infringement of third party patents or any other rights arising from the use of Solar PV modules.

使用太阳能光伏组件过程中所产生侵犯第三方专利权或任何其他权利, 国晟世安科技股份有限公司概不负责。

5、The information in this manual is based on Grand Sunergy's knowledge and experience and is believed to be reliable, but such information including product specification (without limitations) and suggestions Do not constitute a warranty, expresses or implied.

本手册中的信息基于国晟世安科技股份有限公司的知识和经验, 被认为是可靠的, 但包括产品规格 (不限于) 和建议在内的此类信息不构成明示或暗示的保证。

### 1.2、LIMITATION OF LIABILITY 责任范围

Grand Sunergy is not responsible for any form of damage, including but not limited to module operation and system installation error, and personnel injury, hurt, and property loss resulting from failure to follow the instructions in this Manual.

国晟世安科技股份有限公司不对任何形式的损坏负责, 包括但不限于组件操作和系统安装错误, 以及因不遵守本手册中的说明而导致的人员伤亡和财产损失。

## 2、SAFETY PRECAUTIONS 安全措施

### 2.1、WARNING 警告

Before attempting to install, wire, operate and/or service the module and other electrical equipment, all instructions should be read and understood. Direct current (DC) is generated when the battery surface of the module is exposed to direct sunlight or other light sources, and direct contact with the live parts of the module, such as terminals, may result in death of personnel whether connected to the module or not.

对组件进行安装、接线、操作或维护前, 应阅读并理解所有安全细则。当组件电池面直接暴露在阳光或其他光源下时, 会

产生直流电(DC), 无论是否连接组件, 直接接触组件带电部分, 例如接线端子等, 将可能导致人员伤亡。

## 2.2、GENERAL SAFETY 通用安全

Modules rated for use in this application class may be used in system operating at greater than 50V DC or 240W, where general contact access is anticipated. Modules qualified for safety through IEC 61730-1 and IEC 61730-2 and within this application class are considered to meet the requirements for safety class II equipment.

组件可用于公众可能接触的、大于直流50V或240W以上的系统。并且组件通过了IEC61730-1和IEC61730-2两部分, 满足安全II类的要求。

(1) All installation work must comply with the local codes and the relevant international electrical standards.

所有的安装工作必须完全遵守当地法规和相应的国际电气标准。

(2) Grand Sunergy recommends that PV module installation is conducted by personnel who have been professionally trained in PV system installation. Operation by personnel who are not familiar with the relevant safety procedures will be very dangerous.

建议由经过光伏系统安装专业培训的人员进行安装。如由不熟悉相应安全程序的人员操作将会非常危险。

(3) Do not allow unauthorized persons to access the installation area or module storage area.

不允许未经授权的人员接近安装区域或者组件仓储区域。

(4) Protective clothing (non-slip gloves, clothes, etc.) must be worn during installation to prevent direct contact with 30V DC or greater, and to protect hands from sharp edges.

使用恰当的防护措施(防滑手套、工作服等)以避免安装人员与30V直流或更高电压直接接触, 同时避免在安装过程中手直接与组件锋利的边缘接触。

(5) Prior to installation, remove all metallic jewelry to prevent accidental exposure to live circuits.

安装时请不要佩戴金属饰物, 以免戳穿组件, 引起触电危险。

(6) When installing modules in light rain, morning dew, take appropriate measures to prevent water ingress into the connectors, f. e. using connector endcaps.

如果在阴雨、晨雾的天气安装, 需采取适当的措施避免水浸入连接器。

(7) Use electrically insulated tools to reduce the risk of electric shock.

请使用绝缘工具以降低触电的风险。

(8) Do not use or install broken modules.

不要使用或安装已损坏的组件。

(9) External or artificially concentrated sunlight shall not be directed onto the front or back face of the PV module.

外部或人为聚焦的阳光不得直射到光伏组件的正面或背面。

(10) Do not contact module surface if the front or rear glass is broken. This may cause electric shock.

如果在表面玻璃损坏或背板磨损的情况下接触组件的表面或边框可能会引起触电。

(11) Do not attempt to repair, disassemble or move any part of the PV module. The module does not contain any reusable parts.

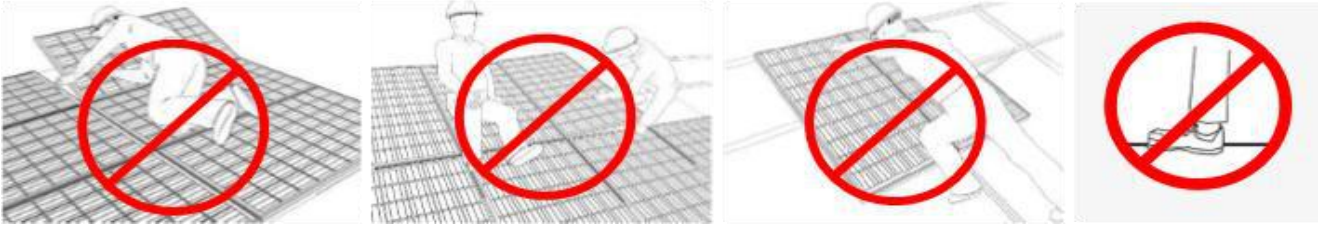
不要试图修复、拆解或移动组件中的任何部分, 组件内没有用户可二次利用的元件。

(12) Do not connect or disconnect the module when it is energized or connected with an external power supply. 当组件有电流或外部电流出现时, 不得连接或断开组件。

## 2.3、HANDLING SAFETY 操作安全

(1) Do not stand, walk on or lean on the module directly.

禁止直接在包装或组件上站立、踩踏、行走或跳跃。



(2) Do not damage or scratch the front or backside surfaces of the module.

请不要损坏或划伤组件的玻璃和背板面。

(3) Do not drag. Scratch, bend the output cable with force or with too tight connection. The insulation of output cable can break and may result in electricity leakage or shock.

请不要拉扯、划伤、用力弯折或过紧安装输出线缆，否则线缆的绝缘部分会被损坏导致电流泄露或触电。

(4) If there is an open fire, please extinguish it with a dry powder extinguisher after disconnecting the power supply, can not use liquid such as water to extinguish the fire.

如有明火请在断开电源后用干粉灭火器扑灭，不可用水等液体扑灭。

(5) Do not install or handle modules when they are wet or during periods of high wind.

请不要在潮湿或者大风期间安装或处理组件。

(6) At the installation site, take care to keep modules and in particular their electrical contacts, clean and dry before installation. If connector cables are left in damp conditions then the contacts may corrode. Any module with corroded contacts should not be used.

在安装现场，请保持组件电器元件的清洁与干燥。如果线缆插头在潮湿条件下互相接触，会被腐蚀。任何被腐蚀的组件都不能被使用。

(7) Please Do not loosen, unscrew or peel the PV module bolts and frame glue. This may lead to a reduction of the module's load rating and potential damage from a fall.

请不要松动、拧下、剥离，光伏组件的螺丝或边框胶，有可能导致组件载荷下降，甚至掉落。

(8) Do not drop PV modules or allow objects to fall down on the PV modules.

请不要让物体直击组件或物体直接掉落在组件上。

(9) Do not touch the terminal box or the ends of the output cables (connectors) with bare hands under sunlight, regardless of whether the PV module is connected to or disconnected from the system.

在阳光下，请不要在没有任何保护的情况下用手直接触摸组件的接线盒、连接器、线缆等带电体，无论光伏组件是否与系统连接。

(10) Do not discard the modules at will; special recycling is required. 禁止组件随意丢弃，需要专门回收。

### 3、UNLOAD/TRANSPORTATION/STORAGE 卸货、运输和存储

Precautions and general safety rules:

预防措施和通用安全细则：

(1) Modules should be stored in a dry and ventilated environment to avoid direct sunlight and moisture and extra precautions should be taken to prevent connectors from being exposed to moisture or sunlight, like using connector endcaps.

应将组件储存在干燥且通风的环境中，同时需要采取措施避免连接器暴露在潮湿或者阳光下，比如使用连接器端帽。

(2) The modules should be stored in the original Grand Sunergy package before installation. Protect the package from damage. Unpack the modules as per the recommended unpacking procedures. The whole process of unpacking, transport and storing should be handled with care.

国晟科技组件在安装前应存储在原包装箱内，请保护好包装不要使其受损。按照建议的拆包步骤打开组件包装。打开、运输和存储过程需小心操作。

(3) Before installation, ensure that all modules and electrical contacts are clean and dry.

安装前，确保所有组件和电气接触都是干净和干燥的。

(4) Unpacking must be carried out by two or more persons at the same time.

拆包时，必须由2个或2个以上人员同时操作。

(5) Handling the modules requires two or more people with nonslip gloves and both hands.

搬运组件时应由2个或以上的人带防滑手套同时双手手持组件搬运。

(6) Do not lift modules by their wires or junction box.

禁止拉扯组件的导线或接线盒来搬运组件。

(7) Do not handle the modules over-head or stack the modules.

禁止头顶组件搬运；禁止堆叠组件。

(8) Do not place excessive loads on the module or twist the module.

禁止在组件上施加过度的载荷或扭曲组件。

(9) Do not drop or place objects (such as tools) on the modules.

禁止掉落或堆放物品（如安装工具）在组件上。

(10) Do not put the modules in a place that is not supported or stable.

禁止将组件置于无可靠支撑或未固定的环境下。

(11) Do not allow the modules to come in contact with sharp-pointed objectives to prevent them from scratches, avoiding a direct impact on the safety of modules.

禁止组件与尖锐物接触，划痕，以免直接影响组件的安全性。

(12) Do not expose the modules and its connectors to any chemical substance (e.g. oil, lubricant, pesticide, etc.).

禁止将组件或者其电气接口暴露在化学物质下（比如油，润滑剂，杀虫剂等）。





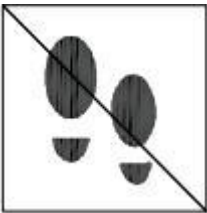
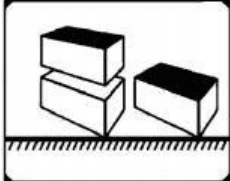
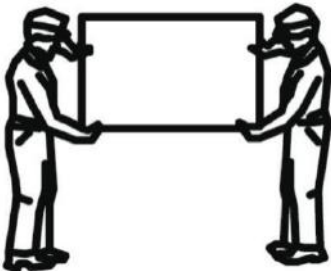
(13) Before the secondary transportation vehicle is started, it should be bundled with net ropes. The rope should be fastened to prevent damage to the modules during the transportation. The speed of the vehicle carrying the modules should be  $\leq 5$  km/h.

在二次搬运车辆启动前，应采用网绳捆绑，绳索应系牢，严防组件在运输过程左右晃动造成损坏：搬运组件车辆行驶速度宜 $\leq 5$ 公里/小时。

(14) Each individual module has a unique serial number laminated behind the glass and another permanently attached to the back-sheet of the module, The last one is on the aluminum frame on the side of the module. Note all serial numbers in an installation for your future records.

每个单独的组件在玻璃后面都有一个唯一的序列号，另一个永久连接到组件的背板上，最后一个在组件侧面铝框上。记下安装中的所有序列号以备将来记录。

### 3.1、MAKERS ON OUTER PACKAGING 包装标示说明

<p>3.1.1 Need both hands to handle it carefully. 需要双手小心操作</p> 	<p>3.1.2 Uninstalled modules must be kept dry, not expose to rain or moisture. 禁止未安装的组件淋雨或者受潮</p> 
<p>3.1.3 Modules in carton are fragile, which must be handled with care. 纸箱中的组件为易碎物品，搬运时应小心轻放</p> 	<p>3.1.4 The packaging must be transported upright. 包装在运输时应竖直向上</p> 
<p>3.1.5 Do not step on the package and module. 禁止在包装箱和组件上面踩踏</p> 	<p>3.1.6 Modules shall be stacked as required, not exceeding the maximum number of layers printed on the outer packaging. (no more than two layers). 堆叠组件时请勿超过外包装箱上印刷标志的最高层数限制（最多堆码2层）</p> 
<p>3.1.8 One module shall be handled by at least two persons together. Modules are placed vertically. 一块组件至少需由2个人同时搬运，组件是竖直放置</p> 	

### 3.2、UNLOADING WARNING 卸货注意事项

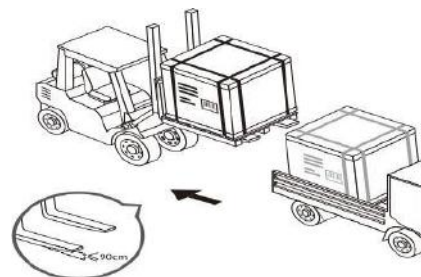
3.2.1 Use a suitable lifting fixture to handle, no more than 2 pallets of modules. Before lifting, check whether the tray and the carton are damaged and whether the hoisting ropes are strong and firm. Two people shall support at the two sides of the righting carton gently to place it on the relatively flat position of the project site.

使用合理的吊装治具，吊装一次性最多允许2托组件。吊装前应确认托盘和纸箱是否有破损及吊装的绳索是否结实、牢固。吊装快着地时，两人一人一边扶正纸箱轻轻放在项目地相对平坦的位置上。



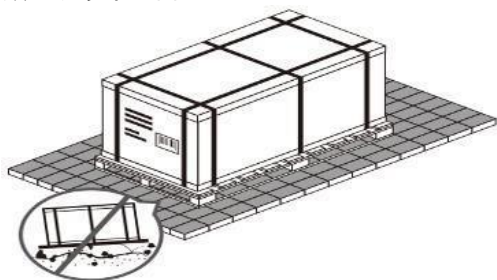
3.2.2 Use a forklift to remove the module pallets from the truck.

请使用叉车将组件从货车上卸下来。



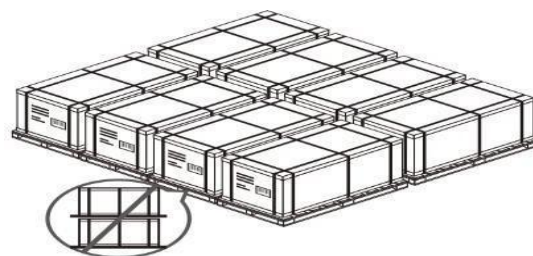
3.2.3 Put the modules on level ground.

将组件放置于水平地面上。



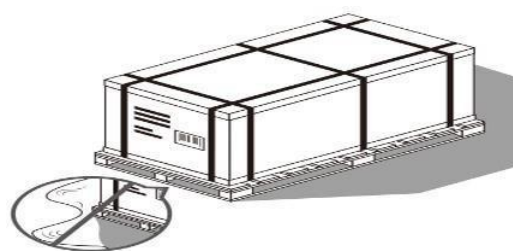
3.2.4 Do not stack the modules at the project site.

禁止在项目地将组件堆码。



3.2.5 Store the module in a dry and ventilated place.

将组件放置在通风干燥处。



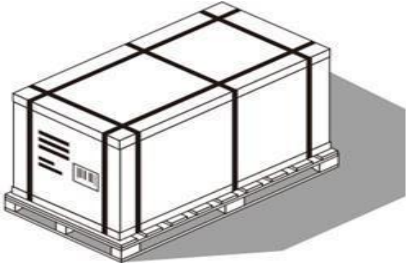
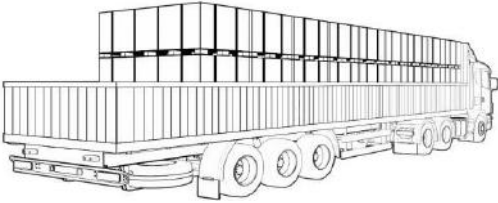
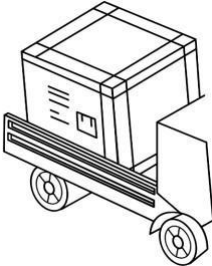

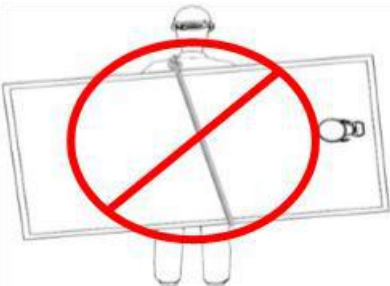

3.2.6 Cover the module with waterproof material to prevent it from moisture.

使用遮雨布盖住组件，防止组件受潮。





### 3.3、SECONDARY TRANSPORT AND WARNING 二次运输及注意事项

<p>3.3.1 Do not remove the original packages if the modules require long-distance transport or long-term storage. 如果组件需长途运输或长期存储，请不要拆除原包装。</p> 	<p>3.3.2 Packaged products can be transported by land, sea or air. During transportation, make sure that the package is fixed securely to the shipping platform without movement. Do not Stack more than two layers on truck. 包装完的成品可以通过陆运、海运、或空运进行运输。在运输过程中：请将包装箱固定在运输平台上，确保包装不会翻滚。正常卡车运输时，最多2层叠加后运输。（以陆运为例）</p> 
<p>3.3.3 Only one layer stacking is only allowed for transport at the project site. 项目现场托运，只允许 1 层运输。</p> 	<p>3.3.4 No transport or handling by pedi-cab or improper vehicle as shown below. 禁止三轮车，马车或其他不合理车辆转运。</p> 
<p>3.3.5 Do not transport the module with rope as shown below. 禁止用绳子背组件。</p> 	<p>3.3.6 Do not carry the modules on the back of one person as shown below. 禁止单人背组件。</p> 

### 3.4、STORAGE 存储

1、Do not remove the original packaging if the module requires long-distance transport or long-term storage.

如果组件需要长途运输或长期存储，请不要拆除包装。

2、Do not expose the modules to rain or moisture. Store the finished product in a well ventilated, waterproof, dry and smooth place.

禁止淋雨或者受潮，请将包装的成品置于通风、防雨、干燥及平整的地方。

3、Do not stack modules more than 2 layers. (moisture<85%RH, temperature range from -20°C to + 40 °C)

组件最多堆码2层（湿度<85%RH；温度：-20°C~+40°C）

4、The module must be installed as soon as possible in the project site and must not be exposed to rain or damp. Grand Sunergy shall not be responsible for any damage or collapse of the modules caused by moisture in the packaging.

到项目地组件应尽快安装，禁止暴露在雨水和潮湿环境中，如因为包装受潮导致组件破损、倒塌等问题，国晟不承担责任。

5、If pallets are stored temporarily outside then place a protective covering over the pallet to protect it from direct weathering and do not stack more than one pallet high.

如果托盘暂时存放在外面，那么在托盘上放置一个保护性的覆盖物，以防止它直接风化，不要堆叠超过一个托盘的高度。

### 3.5. Working Conditions 工作条件

Pmax Temperature Coefficient	HJT= -0.24%/°C / TOPCON= -0.29%/°C
Voc Temperature Coefficient	HJT= -0.24 %/°C / TOPCON= -0.25%/°C
Isc Temperature Coefficient	HJT=+0.04 %/°C / TOPCON=+0.04 %/°C
Operating Temperature	-40~+85°C
Measurement of nominal module operating temperature (NOCT)	44±2 °C
Maximum System Voltage(IEC)	1500V
Grounding conductivity	<0.1Ω
PV module classification	Class II
Insulation Resistance	≥100MΩ

### 3.6. Junction box connector and bypass diode 接线盒连接器和旁路二极管

Connector	
Type: GT4.40A	Changzhou Greateen New Energy Technology Co., Ltd.
Type: Z4S-abcd.41A	Zerun Co.,Ltd.
Type: PV-ZPJ030A. Rated current: 38A	The 40th Institute of China Electronic Technology Group Corporation (no. 116042)

Bypass diode	
Type: GT3050P, IF(AV)=30A, VRPM=50V, Tj(MAX)=200°C for 20A GT903xy(x=1)	ChangzhouGreateen New Energy Technology Co., Ltd.
Type:GT4050D, IF(AV)=40A, VRPM=50V, Tj(MAX)=200°C for 25A GT903xy(x=1,y=1,2)	ChangzhouGreateen New Energy Technology Co., Ltd.
Type:GT5050T, IF(AV)=50A, VRPM=50V, Tj(MAX)=200°C for 30A GT903xy(x=3).	ChangzhouGreateen New Energy Technology Co., Ltd.
Type: 30SQ045 for 20A	Zerun Co.,Ltd.
Type: 35SQ045 for 25A	Zerun Co.,Ltd.
Type: 40SQ045 for 30A	Zerun Co.,Ltd.
Type: GFMK3045P for 20A GFMK4045, GFMK4045C, GFMK3550 for 25A GFMK6045, GFMK6045C for 30A	Ningbo Huayu Photovoltaic Technology Co., Ltd
GFMK3045T, GFMK3045P for 20A GFMK4045C for 25A	Suzhou Yilong Energy Technology Co., Ltd
GFMK3550 for 25A GFMK6045C for 30A	PanJit International Inc.
GFMK4050 for 25A	Jiangsu Zhiqi Electronic Technology Co., Ltd.
GT3550, GFMK4045C for 25A	Jiangsu Changjing Electronics Technology Co., Ltd.

### 3.7. ELECTRICAL RATING 额定功率

#### GSM-MP3/132-MXXX (XXX=630-670)

##### Electrical Characteristics(STC)

Rated Power (Pmp)	635	640	645	650	655	660	665	670
Power Sorting	0~+5W	0~+5W	0~+5W	0~+5W	0~+5W	0~+5W	0~+5W	0~+5W
Power Tolerance	±3%	±3%	±3%	±3%	±3%	±3%	±3%	±3%
Maximum Power Voltage (Vmp)	37.1	37.3	37.5	37.7	37.9	38.1	38.3	38.5
Maximum Power Current (Imp)	17.14	17.19	17.23	17.27	17.31	17.35	17.39	17.43
Open Circuit Voltage (Voc)±3%	44.9	45.1	45.3	45.5	45.7	45.9	46.1	46.3
Short Circuit Current (Isc)±3%	18.21	18.26	18.31	18.35	18.40	18.45	18.50	18.55
Maximum Series Fuse	30	30	30	30	30	30	30	30

##### Electrical Characteristics(NOCT)

Rated Power (Pmp)	471	474	479	483	485	490	494	497
Power Sorting	0~+5W	0~+5W	0~+5W	0~+5W	0~+5W	0~+5W	0~+5W	0~+5W
Power Tolerance	±3%	±3%	±3%	±3%	±3%	±3%	±3%	±3%
Maximum Power Voltage (Vmp)	34.92	35.12	35.22	35.42	35.53	35.72	35.92	36.10
Maximum Power Current (Imp)	13.50	13.53	13.60	13.66	13.69	13.72	13.76	13.78

<b>Open Circuit Voltage (Voc) ±3%</b>	40.71	40.91	41.11	41.31	41.51	41.71	41.91	42.07
<b>Short Circuit Current (Isc)±3%</b>	14.87	14.90	14.90	14.88	14.93	15.00	15.04	15.09
<b>Maximum Series Fuse</b>	30	30	30	30	30	30	30	30

**Electrical Characteristics(low irradiance)**

<b>Rated Power (Pmp)</b>	120	121	122	123	124	125	125	126
<b>Power Sorting</b>	0~+5W	0~+5W	0~+5W	0~+5W	0~+5W	0~+5W	0~+5W	0~+5W
<b>Power Tolerance</b>	±3%	±3%	±3%	±3%	±3%	±3%	±3%	±3%
<b>Maximum Power Voltage (Vmp)</b>	36.02	36.21	36.41	36.60	36.79	36.99	37.18	37.38
<b>Maximum Power Current (Imp)</b>	3.34	3.34	3.35	3.36	3.36	3.37	3.37	3.39
<b>Open Circuit Voltage (Voc) ±3%</b>	41.96	42.15	42.34	42.52	42.71	42.90	43.08	43.27
<b>Short Circuit Current (Isc)±3%</b>	3.60	3.59	3.61	3.62	3.62	3.64	3.65	3.66
<b>Maximum Series Fuse</b>	30	30	30	30	30	30	30	30

**GSM-MP3/120-MXXX (XXX=575-610)**
**Electrical Characteristics(STC)**

<b>Rated Power (Pmp)</b>	575	580	585	590	595	600	605	610
<b>Power Sorting</b>	0~+5W	0~+5W	0~+5W	0~+5W	0~+5W	0~+5W	0~+5W	0~+5W
<b>Power Tolerance</b>	±3%	±3%	±3%	±3%	±3%	±3%	±3%	±3%
<b>Maximum Power Voltage (Vmp)</b>	33.6	33.8	34.0	34.2	34.4	34.6	34.8	35.0
<b>Maximum Power Current (Imp)</b>	17.11	17.16	17.21	17.25	17.30	17.34	17.39	17.44
<b>Open Circuit Voltage (Voc)±3%</b>	40.7	40.9	41.1	41.3	41.5	41.7	41.9	42.1
<b>Short Circuit Current (Isc)±3%</b>	18.16	18.21	18.26	18.31	18.36	18.42	18.47	18.52
<b>Maximum Series Fuse</b>	30	30	30	30	30	30	30	30

**Electrical Characteristics(NOCT)**

<b>Rated Power (Pmp)</b>	427	430	434	438	442	445	449	453
<b>Power Sorting</b>	0~+5W	0~+5W	0~+5W	0~+5W	0~+5W	0~+5W	0~+5W	0~+5W
<b>Power Tolerance</b>	±3%	±3%	±3%	±3%	±3%	±3%	±3%	±3%
<b>Maximum Power Voltage (Vmp)</b>	31.71	31.82	32.02	32.12	32.32	32.43	32.63	32.83
<b>Maximum Power Current (Imp)</b>	13.46	13.51	13.55	13.61	13.69	13.71	13.75	13.80
<b>Open Circuit Voltage (Voc) ±3%</b>	36.89	37.09	37.28	37.48	37.68	37.88	38.08	38.27
<b>Short Circuit Current (Isc)±3%</b>	14.84	14.87	14.90	14.90	14.89	14.95	15.02	15.05
<b>Maximum Series Fuse</b>	30	30	30	30	30	30	30	30

**Electrical Characteristics(low irradiance)**

<b>Rated Power (Pmp)</b>	108	109	110	111	112	113	114	115
<b>Power Sorting</b>	0~+5W	0~+5W	0~+5W	0~+5W	0~+5W	0~+5W	0~+5W	0~+5W
<b>Power Tolerance</b>	±3%	±3%	±3%	±3%	±3%	±3%	±3%	±3%
<b>Maximum Power Voltage (Vmp)</b>	32.62	32.82	33.01	33.21	33.40	33.59	33.79	33.98
<b>Maximum Power Current (Imp)</b>	3.33	3.34	3.34	3.35	3.37	3.37	3.38	3.38
<b>Open Circuit Voltage (Voc) ±3%</b>	38.04	38.22	38.41	38.60	38.78	38.97	39.16	39.34
<b>Short Circuit Current (Isc)±3%</b>	3.58	3.60	3.59	3.61	3.63	3.63	3.64	3.65
<b>Maximum Series</b>	30	30	30	30	30	30	30	30

Fuse							
------	--	--	--	--	--	--	--

**GSM-MP4/156-MXXX (XXX=580-600)**
**Electrical Characteristics(STC)**

Rated Power (Pmp)	580	585	590	595	600
Power Sorting	0~+5W	0~+5W	0~+5W	0~+5W	0~+5W
Power Tolerance	±3%	±3%	±3%	±3%	±3%
Maximum Power Voltage (Vmp)	44.85	45.00	45.15	45.30	45.45
Maximum Power Current (Imp)	12.97	13.04	13.11	13.18	13.25
Open Circuit Voltage (Voc)±3%	53.35	53.5	53.65	53.8	53.95
Short Circuit Current (Isc)±3%	13.71	13.78	13.85	13.92	13.99
Maximum Series Fuse	25	25	25	25	25

**Electrical Characteristics(NOCT)**

Rated Power (Pmp)	431	434	437	442	446
Power Sorting	0~+5W	0~+5W	0~+5W	0~+5W	0~+5W
Power Tolerance	±3%	±3%	±3%	±3%	±3%
Maximum Power Voltage (Vmp)	42.32	42.36	42.52	42.55	42.71
Maximum Power Current (Imp)	10.20	10.27	10.32	10.40	10.48
Open Circuit Voltage (Voc) ±3%	48.36	48.51	48.67	48.83	48.98
Short Circuit Current (Isc)±3%	11.20	11.25	11.30	11.33	11.35
Maximum Series Fuse	25	25	25	25	25

**Electrical Characteristics(low irradiance)**

Rated Power (Pmp)	109	110	111	112	113
Power Sorting	0~+5W	0~+5W	0~+5W	0~+5W	0~+5W
Power Tolerance	±3%	±3%	±3%	±3%	±3%
Maximum Power Voltage (Vmp)	43.54	43.69	43.83	43.99	44.13
Maximum Power Current (Imp)	2.52	2.54	2.54	2.56	2.58
Open Circuit Voltage (Voc) ±3%	49.87	50.00	50.14	50.28	50.42
Short Circuit Current (Isc)±3%	2.70	2.72	2.73	2.74	2.76
Maximum Series Fuse	25	25	25	25	25

**GSM-MP4/144-MXXX (XXX=535-550)**
**Electrical Characteristics(STC)**

Rated Power (Pmp)	535	540	545	550
Power Sorting	0~+5W	0~+5W	0~+5W	0~+5W
Power Tolerance	±3%	±3%	±3%	±3%
Maximum Power Voltage (Vmp)	41.5	41.65	41.8	41.95
Maximum Power Current (Imp)	12.9	12.97	13.04	13.11
Open Circuit Voltage (Voc)±3%	49.35	49.5	49.65	49.80
Short Circuit Current (Isc)±3%	13.78	13.85	13.92	13.99
Maximum Series Fuse	25	25	25	25

**Electrical Characteristics (NOCT)**

Rated Power (Pmp)	397	401	404	408
Power Sorting	0~+5W	0~+5W	0~+5W	0~+5W
Power Tolerance	±3%	±3%	±3%	±3%
Maximum Power Voltage (Vmp)	39.16	39.21	39.36	39.40
Maximum Power Current (Imp)	10.15	10.21	10.26	10.35
Open Circuit Voltage (Voc)	44.73	44.89	45.04	45.20
Short Circuit Current (Isc)	11.26	11.31	11.36	11.38
Maximum Series Fuse	25	25	25	25

**Electrical Characteristics (Low irradiance)**

Rated Power (Pmp)	101	102	103	104
Power Sorting	0~+5W	0~+5W	0~+5W	0~+5W
Power Tolerance	±3%	±3%	±3%	±3%
Maximum Power Voltage (Vmp)	40.29	40.44	40.58	40.73
Maximum Power Current (Imp)	2.51	2.52	2.53	2.55
Open Circuit Voltage (Voc) ±3%	46.13	46.26	46.40	46.55
Short Circuit Current (Isc) ±3%	2.72	2.74	2.74	2.76
Maximum Series Fuse	25	25	25	25

**GSM-MP4/120-MXXX (xxx=450-460)**
**Electrical Characteristics(STC)**

<b>Rated Power (Pmp)</b>	450	455	460
<b>Power Sorting</b>	0~+5W	0~+5W	0~+5W
<b>Power Tolerance</b>	±3%	±3%	±3%
<b>Maximum Power Voltage (Vmp)</b>	33.91	34.06	34.2
<b>Maximum Power Current (Imp)</b>	13.27	13.36	13.45
<b>Open Circuit Voltage (Voc)±3%</b>	41.18	41.33	41.48
<b>Short Circuit Current (Isc)±3%</b>	13.85	13.93	14.01
<b>Maximum Series Fuse</b>	25	25	25

**Electrical Characteristics(NOCT)**

<b>Rated Power (Pmp)</b>	334	338	341
<b>Power Sorting</b>	0~+5W	0~+5W	0~+5W
<b>Power Tolerance</b>	±3%	±3%	±3%
<b>Maximum Power Voltage (Vmp)</b>	32.00	32.06	32.20
<b>Maximum Power Current (Imp)</b>	10.44	10.52	10.59
<b>Open Circuit Voltage (Voc) ±3%</b>	37.32	37.48	37.63
<b>Short Circuit Current (Isc)±3%</b>	11.32	11.37	11.43
<b>Maximum Series Fuse</b>	25	25	25

**Electrical Characteristics(low irradiance)**

<b>Rated Power (Pmp)</b>	85	86	87
<b>Power Sorting</b>	0~+5W	0~+5W	0~+5W
<b>Power Tolerance</b>	±3%	±3%	±3%
<b>Maximum Power Voltage (Vmp)</b>	32.92	33.07	33.20
<b>Maximum Power Current (Imp)</b>	2.58	2.60	2.61
<b>Open Circuit Voltage (Voc) ±3%</b>	38.49	38.62	38.77
<b>Short Circuit Current (Isc)±3%</b>	2.73	2.75	2.76
<b>Maximum Series Fuse</b>	25	25	25

**GSM-MP4/108-Mxxx (xxx=400-415)**
**Electrical Characteristics(STC)**

<b>Rated Power (Pmp)</b>	400	405	410	415
<b>Power Sorting</b>	0~+5W	0~+5W	0~+5W	0~+5W
<b>Power Tolerance</b>	±3%	±3%	±3%	±3%
<b>Maximum Power Voltage (Vmp)</b>	30.42	30.52	30.62	30.79
<b>Maximum Power Current (Imp)</b>	13.15	13.27	13.39	13.48
<b>Open Circuit Voltage (Voc)±3%</b>	36.98	37.06	37.14	37.31
<b>Short Circuit Current (Isc)±3%</b>	13.78	13.85	13.92	14.01
<b>Maximum Series Fuse</b>	25	25	25	25

**Electrical Characteristics(NOCT)**

<b>Rated Power (Pmp)</b>	297	300	304	308
<b>Power Sorting</b>	0~+5W	0~+5W	0~+5W	0~+5W
<b>Power Tolerance</b>	±3%	±3%	±3%	±3%
<b>Maximum Power Voltage (Vmp)</b>	28.71	28.73	28.83	28.92
<b>Maximum Power Current (Imp)</b>	10.34	10.45	10.54	10.64
<b>Open Circuit Voltage (Voc) ±3%</b>	33.52	33.61	33.69	33.86
<b>Short Circuit Current (Isc)±3%</b>	11.26	11.31	11.36	11.40
<b>Maximum Series Fuse</b>	25	25	25	25

**Electrical Characteristics(low irradiance)**

<b>Rated Power (Pmp)</b>	75	76	77	78
<b>Power Sorting</b>	0~+5W	0~+5W	0~+5W	0~+5W
<b>Power Tolerance</b>	±3%	±3%	±3%	±3%
<b>Maximum Power Voltage (Vmp)</b>	29.53	29.63	29.73	29.90
<b>Maximum Power Current (Imp)</b>	2.56	2.58	2.60	2.62
<b>Open Circuit Voltage (Voc) ±3%</b>	34.56	34.63	34.71	34.87
<b>Short Circuit Current (Isc)±3%</b>	2.72	2.74	2.74	2.76
<b>Maximum Series Fuse</b>	25	25	25	25

**GSM-MP4/144-MBxxx (xxx=530-545)**
**Electrical Characteristics(STC)**

<b>Rated Power (Pmp)</b>	530	535	540	545
<b>Power Sorting</b>	0~+5W	0~+5W	0~+5W	0~+5W
<b>Power Tolerance</b>	±3%	±3%	±3%	±3%
<b>Maximum Power Voltage (Vmp)</b>	41.35	41.5	41.65	41.8
<b>Maximum Power Current (Imp)</b>	12.83	12.9	12.97	13.04
<b>Open Circuit Voltage (Voc)±3%</b>	49.2	49.35	49.5	49.65
<b>Short Circuit Current (Isc)±3%</b>	13.71	13.78	13.85	13.92
<b>Maximum Series Fuse</b>	25	25	25	25

**Electrical Characteristics(NOCT)**

<b>Rated Power (Pmp)</b>	391	395	399	403
<b>Power Sorting</b>	0~+5W	0~+5W	0~+5W	0~+5W
<b>Power Tolerance</b>	±3%	±3%	±3%	±3%
<b>Maximum Power Voltage (Vmp)</b>	38.26	38.31	38.36	38.40
<b>Maximum Power Current (Imp)</b>	10.21	10.30	10.39	10.48
<b>Open Circuit Voltage (Voc) ±3%</b>	45.78	45.83	45.87	45.92
<b>Short Circuit Current (Isc)±3%</b>	10.99	11.06	11.16	11.27
<b>Maximum Series Fuse</b>	25	25	25	25

**Electrical Characteristics(low irradiance)**

<b>Rated Power (Pmp)</b>	124	125	126	127
<b>Power Sorting</b>	0~+5W	0~+5W	0~+5W	0~+5W
<b>Power Tolerance</b>	±3%	±3%	±3%	±3%
<b>Maximum Power Voltage (Vmp)</b>	40.14	40.29	40.43	40.59
<b>Maximum Power Current (Imp)</b>	2.49	2.51	2.51	2.53
<b>Open Circuit Voltage (Voc) ±3%</b>	45.99	46.12	46.26	46.40
<b>Short Circuit Current (Isc)±3%</b>	2.70	2.72	2.73	2.74
<b>Maximum Series Fuse</b>	25	25	25	25

**GSM-MP4/120-MBxxx (xxx=445-455)**
**Electrical Characteristics(STC)**

<b>Rated Power (Pmp)</b>	445	450	455
<b>Power Sorting</b>	0~+5W	0~+5W	0~+5W
<b>Power Tolerance</b>	±3%	±3%	±3%
<b>Maximum Power Voltage (Vmp)</b>	33.77	33.91	34.06
<b>Maximum Power Current (Imp)</b>	13.18	13.27	13.36
<b>Open Circuit Voltage (Voc)±3%</b>	41.03	41.18	41.33
<b>Short Circuit Current (Isc)±3%</b>	13.78	13.85	13.93
<b>Maximum Series Fuse</b>	25	25	25

**Electrical Characteristics(NOCT)**

<b>Rated Power (Pmp)</b>	328	332	336
<b>Power Sorting</b>	0~+5W	0~+5W	0~+5W
<b>Power Tolerance</b>	±3%	±3%	±3%
<b>Maximum Power Voltage (Vmp)</b>	31.25	31.30	31.37
<b>Maximum Power Current (Imp)</b>	10.49	10.60	10.70
<b>Open Circuit Voltage (Voc) ±3%</b>	38.18	38.24	38.30
<b>Short Circuit Current (Isc)±3%</b>	11.04	11.12	11.23
<b>Maximum Series Fuse</b>	25	25	25

**Electrical Characteristics(low irradiance)**

<b>Rated Power (Pmp)</b>	104	105	106
<b>Power Sorting</b>	0~+5W	0~+5W	0~+5W
<b>Power Tolerance</b>	±3%	±3%	±3%
<b>Maximum Power Voltage (Vmp)</b>	32.78	32.92	33.06
<b>Maximum Power Current (Imp)</b>	2.56	2.58	2.59
<b>Open Circuit Voltage (Voc) ±3%</b>	38.35	38.49	38.63
<b>Short Circuit Current (Isc)±3%</b>	2.71	2.73	2.75
<b>Maximum Series Fuse</b>	25	25	25

**GSM-MP4/108-MBxxx (xxx=395-410)**
**Electrical Characteristics(STC)**

<b>Rated Power (Pmp)</b>	395	400	405	410
<b>Power Sorting</b>	0~+5W	0~+5W	0~+5W	0~+5W
<b>Power Tolerance</b>	±3%	±3%	±3%	±3%
<b>Maximum Power Voltage (Vmp)</b>	30.32	30.42	30.52	30.62
<b>Maximum Power Current (Imp)</b>	13.03	13.15	13.27	13.39
<b>Open Circuit Voltage (Voc)±3%</b>	36.9	36.98	37.06	37.14
<b>Short Circuit Current (Isc)±3%</b>	13.71	13.78	13.85	13.92
<b>Maximum Series Fuse</b>	25	25	25	25

**Electrical Characteristics(NOCT)**

<b>Rated Power (Pmp)</b>	291	295	299	303
<b>Power Sorting</b>	0~+5W	0~+5W	0~+5W	0~+5W
<b>Power Tolerance</b>	±3%	±3%	±3%	±3%
<b>Maximum Power Voltage (Vmp)</b>	34.33	34.34	34.34	34.35
<b>Maximum Power Current (Imp)</b>	10.99	11.06	11.16	11.27
<b>Open Circuit Voltage (Voc) ±3%</b>	28.05	28.08	28.11	28.13
<b>Short Circuit Current (Isc)±3%</b>	10.37	10.50	10.63	10.76
<b>Maximum Series Fuse</b>	25	25	25	25

**Electrical Characteristics(low irradiance)**

<b>Rated Power (Pmp)</b>	93	94	95	95
<b>Power Sorting</b>	0~+5W	0~+5W	0~+5W	0~+5W
<b>Power Tolerance</b>	±3%	±3%	±3%	±3%
<b>Maximum Power Voltage (Vmp)</b>	29.43	29.53	29.63	29.73
<b>Maximum Power Current (Imp)</b>	2.53	2.56	2.57	2.60
<b>Open Circuit Voltage (Voc) ±3%</b>	34.49	34.56	34.64	34.71
<b>Short Circuit Current (Isc)±3%</b>	2.70	2.72	2.73	2.74
<b>Maximum Series Fuse</b>	25	25	25	25

**GSM-MP3/132-BMDGXXX (xxx=630-670)**
**Electrical Characteristics(STC)**

<b>Rated Power (Pmp)</b>	635	640	645	650	655	660	665	670
<b>Power Sorting</b>	0~+5W	0~+5W	0~+5W	0~+5W	0~+5W	0~+5W	0~+5W	0~+5W
<b>Power Tolerance</b>	±3%	±3%	±3%	±3%	±3%	±3%	±3%	±3%
<b>Maximum Power Voltage (Vmp)</b>	37.1	37.3	37.5	37.7	37.9	38.1	38.3	38.5
<b>Maximum Power Current (Imp)</b>	17.14	17.19	17.23	17.27	17.31	17.35	17.39	17.43
<b>Open Circuit Voltage (Voc)±3%</b>	44.9	45.1	45.3	45.5	45.7	45.9	46.1	46.3
<b>Short Circuit Current (Isc)±3%</b>	18.21	18.26	18.31	18.35	18.4	18.45	18.5	18.55
<b>Maximum Series Fuse</b>	30	30	30	30	30	30	30	30

**Electrical Characteristics (NOCT)**

<b>Rated Power (Pmp)</b>	471	474	479	483	485	490	494	496
<b>Power Sorting</b>	0~+5W	0~+5W	0~+5W	0~+5W	0~+5W	0~+5W	0~+5W	0~+5W
<b>Power Tolerance</b>	±3%	±3%	±3%	±3%	±3%	±3%	±3%	±3%
<b>Maximum Power Voltage (Vmp)</b>	34.92	35.12	35.22	35.42	35.53	35.72	35.92	36.03
<b>Maximum Power Current (Imp)</b>	13.50	13.53	13.60	13.66	13.69	13.72	13.76	13.79
<b>Open Circuit Voltage (Voc)±3%</b>	40.71	40.91	41.11	41.31	41.51	41.71	41.91	42.01
<b>Short Circuit Current (Isc)±3%</b>	14.87	14.90	14.90	14.88	14.93	15.00	15.04	15.09
<b>Maximum Series Fuse</b>	30	30	30	30	30	30	30	30



**GSM-MP3/120-BMDGXXX(xxx=575-610)**
**Electrical Characteristics(STC)**

Rated Power (Pmp)	575	580	585	590	595	600	605	610
Power Sorting	0~+5W	0~+5W	0~+5W	0~+5W	0~+5W	0~+5W	0~+5W	0~+5W
Power Tolerance	±3%	±3%	±3%	±3%	±3%	±3%	±3%	±3%
Maximum Power Voltage (Vmp)	33.6	33.8	34	34.2	34.4	34.6	34.8	35
Maximum Power Current (Imp)	17.11	17.16	17.21	17.25	17.3	17.34	17.39	17.44
Open Circuit Voltage (Voc)±3%	40.7	40.9	41.1	41.3	41.5	41.7	41.9	42.1
Short Circuit Current (Isc)±3%	18.16	18.21	18.26	18.31	18.36	18.42	18.47	18.52
Maximum Series Fuse	30	30	30	30	30	30	30	30

**Electrical Characteristics(NOCT)**

Rated Power (Pmp)	427	430	434	438	442	445	449	453
Power Sorting	0~+5W	0~+5W	0~+5W	0~+5W	0~+5W	0~+5W	0~+5W	0~+5W
Power Tolerance	±3%	±3%	±3%	±3%	±3%	±3%	±3%	±3%
Maximum Power Voltage (Vmp)	31.71	31.82	32.02	32.12	32.32	32.43	32.63	32.83
Maximum Power Current (Imp)	13.46	13.51	13.55	13.61	13.69	13.71	13.75	13.80
Open Circuit Voltage (Voc) ±3%	36.89	37.09	37.28	37.48	37.68	37.88	38.08	38.27
Short Circuit Current (Isc) ±3%	14.84	14.87	14.90	14.90	14.89	14.95	15.02	15.05
Maximum Series Fuse	30	30	30	30	30	30	30	30

**GSM-MP4/144-BMDGXXX (xxx=530-550)**
**Electrical Characteristics(STC)**

Rated Power (Pmp)	530	535	540	545	550
Power Sorting	0~+5W	0~+5W	0~+5W	0~+5W	0~+5W
Power Tolerance	±3%	±3%	±3%	±3%	±3%
Maximum Power Voltage (Vmp)	41.35	41.5	41.65	41.8	41.95
Maximum Power Current (Imp)	12.83	12.9	12.97	13.04	13.11
Open Circuit Voltage (Voc)±3%	49.20	49.35	49.5	49.65	49.8
Short Circuit Current (Isc)±3%	13.71	13.78	13.85	13.92	13.99
Maximum Series Fuse	30	30	30	30	30

**Electrical Characteristics(NOCT)**

Rated Power (Pmp)	393	397	400	404	409
Power Sorting	0~+5W	0~+5W	0~+5W	0~+5W	0~+5W
Power Tolerance	±3%	±3%	±3%	±3%	±3%
Maximum Power Voltage (Vmp)	39.02	39.07	39.22	39.26	39.42
Maximum Power Current (Imp)	10.09	10.16	10.21	10.29	10.37
Open Circuit Voltage (Voc) ±3%	44.59	44.75	44.91	45.06	45.22
Short Circuit Current (Isc) ±3%	11.20	11.25	11.30	11.33	11.35
Maximum Series Fuse	30	30	30	30	30

**GSM-MP4/120-BMDGXXX (xxx=450-460)**
**Electrical Characteristics(STC)**

Rated Power (Pmp)	450	455	460
Power Sorting	0~+5W	0~+5W	0~+5W
Power Tolerance	±3%	±3%	±3%
Maximum Power Voltage (Vmp)	33.91	34.06	34.2
Maximum Power Current (Imp)	13.27	13.36	13.45
Open Circuit Voltage (Voc)±3%	41.18	41.33	41.48
Short Circuit Current (Isc)±3%	13.85	13.93	14.01
Maximum Series Fuse	30	30	30

**Electrical Characteristics (NOCT)**

Rated Power (Pmp)	334	338	341
Power Sorting	0~+5W	0~+5W	0~+5W
Power Tolerance	±3%	±3%	±3%
Maximum Power Voltage (Vmp)	32.00	32.06	32.20
Maximum Power Current (Imp)	10.44	10.52	10.59

<b>Open Circuit Voltage (Voc)±3%</b>	37.32	37.48	37.63
<b>Short Circuit Current (Isc)±3%</b>	11.32	11.37	11.43
<b>Maximum Series Fuse</b>	30	30	30

**GSM-MP4/108-BMDGXXX (xxx=400-415)**
**Electrical Characteristics(STC)**

<b>Rated Power (Pmp)</b>	400	405	410	415
<b>Power Sorting</b>	0~+5W	0~+5W	0~+5W	0~+5W
<b>Power Tolerance</b>	±3%	±3%	±3%	±3%
<b>Maximum Power Voltage (Vmp)</b>	30.42	30.52	30.62	30.79
<b>Maximum Power Current (Imp)</b>	13.15	13.27	13.39	13.48
<b>Open Circuit Voltage (Voc) ±3%</b>	36.98	37.06	37.14	37.31
<b>Short Circuit Current (Isc) ±3%</b>	13.78	13.85	13.92	14.01
<b>Maximum Series Fuse</b>	30	30	30	30

**Electrical Characteristics(NOCT)**

<b>Rated Power (Pmp)</b>	297	300	304	308
<b>Power Sorting</b>	0~+5W	0~+5W	0~+5W	0~+5W
<b>Power Tolerance</b>	±3%	±3%	±3%	±3%
<b>Maximum Power Voltage (Vmp)</b>	28.71	28.73	28.83	28.92
<b>Maximum Power Current (Imp)</b>	10.34	10.45	10.54	10.64
<b>Open Circuit Voltage (Voc) ±3%</b>	33.52	33.61	33.69	33.86
<b>Short Circuit Current (Isc) ±3%</b>	11.26	11.31	11.36	11.40
<b>Maximum Series Fuse</b>	30	30	30	30

**GSM-MH3/132-BHDGXXX(xxx=700-740)**
**Electrical Characteristics(STC)**

<b>Rated Power (Pmp)</b>	700	705	710	715	720	725	730	735	740
<b>Power Sorting</b>	0~+5W	0~+5W	0~+5W	0~+5W	0~+5W	0~+5W	0~+5W	0~+5W	0~+5W
<b>Power Tolerance</b>	±3%	±3%	±3%	±3%	±3%	±3%	±3%	±3%	±3%
<b>Maximum Power Voltage (Vmp)</b>	41.79	41.93	42.07	42.21	42.37	42.51	42.63	42.77	42.92
<b>Maximum Power Current (Imp)</b>	16.76	16.83	16.89	16.95	17.01	17.07	17.13	17.19	17.25
<b>Open Circuit Voltage (Voc)±3%</b>	49.73	49.88	50.02	50.16	50.32	50.46	50.66	50.80	50.95
<b>Short Circuit Current (Isc)±3%</b>	17.79	17.85	17.91	17.97	18.03	18.09	18.20	18.26	18.32
<b>Maximum Series Fuse</b>	30	30	30	30	30	30	30	30	30

**Electrical Characteristics(BSTC)**

<b>Rated Power (Pmp)</b>	772	778	783	788	793	798	803	808	813
<b>Power Sorting</b>	0~+5W	0~+5W	0~+5W	0~+5W	0~+5W	0~+5W	0~+5W	0~+5W	0~+5W
<b>Power Tolerance</b>	±3%	±3%	±3%	±3%	±3%	±3%	±3%	±3%	±3%
<b>Maximum Power Voltage (Vmp)</b>	41.93	42.07	42.21	42.35	42.51	42.65	42.77	42.91	43.06
<b>Maximum Power Current (Imp)</b>	18.84	18.91	18.97	19.03	19.09	19.15	19.21	19.27	19.33
<b>Open Circuit Voltage (Voc) ±3%</b>	49.92	50.07	50.21	50.35	50.51	50.65	50.85	50.99	51.14
<b>Short Circuit Current (Isc) ±3%</b>	19.97	20.03	20.09	20.15	20.21	20.27	20.38	20.44	20.50
<b>Maximum Series Fuse</b>	30	30	30	30	30	30	30	30	30

**GSM-MH3/120-BHDGXXX(xxx=630-655)**
**Electrical Characteristics(STC)**

<b>Rated Power (Pmp)</b>	630	635	640	645	650	655
<b>Power Sorting</b>	0~+5W	0~+5W	0~+5W	0~+5W	0~+5W	0~+5W
<b>Power Tolerance</b>	±3%	±3%	±3%	±3%	±3%	±3%
<b>Maximum Power Voltage (Vmp)</b>	38.04	38.19	38.35	38.51	38.67	38.75
<b>Maximum Power Current (Imp)</b>	16.57	16.63	16.69	16.75	16.81	16.91
<b>Open Circuit Voltage (Voc)±3%</b>	45.30	45.48	45.66	45.84	46.02	46.12
<b>Short Circuit Current (Isc)±3%</b>	17.37	17.43	17.49	17.55	17.61	17.71
<b>Maximum Series Fuse</b>	30	30	30	30	30	30

**Electrical Characteristics(BSTC)**

<b>Rated Power (Pmp)</b>	695	700	707	713	718	723
--------------------------	-----	-----	-----	-----	-----	-----

<b>Power Sorting</b>	0~+5W	0~+5W	0~+5W	0~+5W	0~+5W	0~+5W
<b>Power Tolerance</b>	±3%	±3%	±3%	±3%	±3%	±3%
<b>Maximum Power Voltage (Vmp)</b>	38.11	38.29	38.47	38.65	38.83	39.01
<b>Maximum Power Current (Imp)</b>	18.26	18.32	18.38	18.44	18.50	18.56
<b>Open Circuit Voltage (Voc) ±3%</b>	45.35	45.53	45.71	45.89	46.07	46.25
<b>Short Circuit Current (Isc) ±3%</b>	19.11	19.17	19.23	19.29	19.35	19.41
<b>Maximum Series Fuse</b>	30	30	30	30	30	30

**GSM-MH4/156-BHDGXXX(xxx=635-655) Electrical Characteristics(STC)**

<b>Rated Power (Pmp)</b>	635	640	645	650	655
<b>Power Sorting</b>	0~+5W	0~+5W	0~+5W	0~+5W	0~+5W
<b>Power Tolerance</b>	±3%	±3%	±3%	±3%	±3%
<b>Maximum Power Voltage (Vmp)</b>	49.57	49.67	49.77	49.85	49.94
<b>Maximum Power Current (Imp)</b>	12.81	12.90	12.98	13.05	13.13
<b>Open Circuit Voltage (Voc)±3%</b>	58.48	58.53	58.61	58.67	58.83
<b>Short Circuit Current (Isc)±3%</b>	13.42	13.54	13.63	13.74	13.85
<b>Maximum Series Fuse</b>	25	25	25	25	25

**Electrical Characteristics(BSTC)**

<b>Rated Power (Pmp)</b>	687	692	697	702	707
<b>Power Sorting</b>	0~+5W	0~+5W	0~+5W	0~+5W	0~+5W
<b>Power Tolerance</b>	±3%	±3%	±3%	±3%	±3%
<b>Maximum Power Voltage (Vmp)</b>	49.57	49.67	49.77	49.85	50.03
<b>Maximum Power Current (Imp)</b>	13.86	13.93	14.00	14.08	14.16
<b>Open Circuit Voltage (Voc) ±3%</b>	58.48	58.53	58.61	58.67	58.83
<b>Short Circuit Current (Isc) ±3%</b>	14.57	14.66	14.73	14.82	15.01
<b>Maximum Series Fuse</b>	25	25	25	25	25

**GSM-MH4/144-BHDGXXX(xxx=590-610) Electrical Characteristics(STC)**

<b>Rated Power (Pmp)</b>	590	595	600	605	610
<b>Power Sorting</b>	0~+5W	0~+5W	0~+5W	0~+5W	0~+5W
<b>Power Tolerance</b>	±3%	±3%	±3%	±3%	±3%
<b>Maximum Power Voltage (Vmp)</b>	45.44	45.65	45.86	46.07	46.28
<b>Maximum Power Current (Imp)</b>	13.00	13.05	13.10	13.15	13.20
<b>Open Circuit Voltage (Voc)±3%</b>	54.33	54.52	54.71	54.90	55.09
<b>Short Circuit Current (Isc)±3%</b>	13.46	13.51	13.56	13.61	13.66
<b>Maximum Series Fuse</b>	25	25	25	25	25

**Electrical Characteristics(BSTC)**

<b>Rated Power (Pmp)</b>	674	679	684	689	694
<b>Power Sorting</b>	0~+5W	0~+5W	0~+5W	0~+5W	0~+5W
<b>Power Tolerance</b>	±3%	±3%	±3%	±3%	±3%
<b>Maximum Power Voltage (Vmp)</b>	47.04	47.25	47.46	47.67	47.88
<b>Maximum Power Current (Imp)</b>	14.33	14.37	14.41	14.45	14.49
<b>Open Circuit Voltage (Voc) ±3%</b>	56.13	56.32	56.51	56.70	56.89
<b>Short Circuit Current (Isc) ±3%</b>	14.84	14.88	14.92	14.96	15.00
<b>Maximum Series Fuse</b>	25	25	25	25	25

**GSM-MH4/120-BHDGXXX(xxx=480-500) Electrical Characteristics(STC)**

<b>Rated Power (Pmp)</b>	480	485	490	495	500
<b>Power Sorting</b>	0~+5W	0~+5W	0~+5W	0~+5W	0~+5W
<b>Power Tolerance</b>	±3%	±3%	±3%	±3%	±3%
<b>Maximum Power Voltage (Vmp)</b>	37.38	37.60	37.82	38.03	38.24
<b>Maximum Power Current (Imp)</b>	12.86	12.92	12.98	13.03	13.08
<b>Open Circuit Voltage (Voc)±3%</b>	44.82	45.02	45.22	45.41	45.60
<b>Short Circuit Current (Isc)±3%</b>	13.34	13.39	13.44	13.49	13.54
<b>Maximum Series Fuse</b>	25	25	25	25	25

**Electrical Characteristics(BSTC)**

<b>Rated Power (Pmp)</b>	532	536	541	546	550
<b>Power Sorting</b>	0~+5W	0~+5W	0~+5W	0~+5W	0~+5W
<b>Power Tolerance</b>	±3%	±3%	±3%	±3%	±3%
<b>Maximum Power Voltage (Vmp)</b>	37.38	37.60	37.82	38.03	38.24
<b>Maximum Power Current (Imp)</b>	14.23	14.27	14.31	14.35	14.39
<b>Open Circuit Voltage (Voc) ±3%</b>	44.82	45.02	45.22	45.41	45.60
<b>Short Circuit Current (Isc) ±3%</b>	14.74	14.78	14.82	14.86	14.90
<b>Maximum Series Fuse</b>	25	25	25	25	25

**GSM-MH4/108-BHDGXXX(xxx=430-450) Electrical Characteristics(STC)**

<b>Rated Power (Pmp)</b>	430	435	440	445	450
<b>Power Sorting</b>	0~+5W	0~+5W	0~+5W	0~+5W	0~+5W
<b>Power Tolerance</b>	±3%	±3%	±3%	±3%	±3%
<b>Maximum Power Voltage (Vmp)</b>	33.54	33.79	34.04	34.29	34.54
<b>Maximum Power Current (Imp)</b>	12.83	12.88	12.93	12.98	13.03
<b>Open Circuit Voltage (Voc)±3%</b>	40.30	40.55	40.80	41.05	41.30
<b>Short Circuit Current (Isc)±3%</b>	13.28	13.33	13.38	13.43	13.48
<b>Maximum Series Fuse</b>	25	25	25	25	25

**Electrical Characteristics(BSTC)**

<b>Rated Power (Pmp)</b>	489	494	499	504	509
<b>Power Sorting</b>	0~+5W	0~+5W	0~+5W	0~+5W	0~+5W
<b>Power Tolerance</b>	±3%	±3%	±3%	±3%	±3%
<b>Maximum Power Voltage (Vmp)</b>	34.49	34.74	34.99	35.24	35.49
<b>Maximum Power Current (Imp)</b>	14.18	14.22	14.26	14.30	14.34
<b>Open Circuit Voltage (Voc) ±3%</b>	41.32	41.57	41.82	42.07	42.32
<b>Short Circuit Current (Isc) ±3%</b>	14.67	14.71	14.75	14.89	15.03
<b>Maximum Series Fuse</b>	25	25	25	25	25

**GSM-MT4/156-BTDGXXX(xxx=620-640)**
**Electrical Characteristics(STC)**

<b>Rated Power (Pmp)</b>	620	625	630	635	640
<b>Power Sorting</b>	0~+5W	0~+5W	0~+5W	0~+5W	0~+5W
<b>Power Tolerance</b>	±3%	±3%	±3%	±3%	±3%
<b>Maximum Power Voltage (Vmp)</b>	45.78	45.91	46.04	46.17	46.30
<b>Maximum Power Current (Imp)</b>	13.55	13.62	13.69	13.76	13.83
<b>Open Circuit Voltage (Voc)±3%</b>	55.56	55.71	55.86	56.01	56.16
<b>Short Circuit Current (Isc)±3%</b>	14.24	14.31	14.38	14.45	14.52
<b>Maximum Series Fuse</b>	25	25	25	25	25

**Electrical Characteristics(NOCT)**

<b>Rated Power (Pmp)</b>	466	470	474	478	482
<b>Power Sorting</b>	0~+5W	0~+5W	0~+5W	0~+5W	0~+5W
<b>Power Tolerance</b>	±3%	±3%	±3%	±3%	±3%
<b>Maximum Power Voltage (Vmp)</b>	43.16	43.31	43.46	43.50	43.58
<b>Maximum Power Current (Imp)</b>	10.82	10.87	10.93	11.03	11.08
<b>Open Circuit Voltage (Voc) ±3%</b>	52.71	52.86	53.01	53.16	53.31
<b>Short Circuit Current (Isc) ±3%</b>	11.43	11.49	11.56	11.62	11.68
<b>Maximum Series Fuse</b>	25	25	25	25	25

**GSM-MT4/144-BTDGXXX(xxx=570-590)**
**Electrical Characteristics(STC)**

<b>Rated Power (Pmp)</b>	570	575	580	585	590
<b>Power Sorting</b>	0~+5W	0~+5W	0~+5W	0~+5W	0~+5W
<b>Power Tolerance</b>	±3%	±3%	±3%	±3%	±3%
<b>Maximum Power Voltage (Vmp)</b>	42.32	42.47	42.62	42.77	42.92
<b>Maximum Power Current (Imp)</b>	13.47	13.54	13.61	13.68	13.75
<b>Open Circuit Voltage (Voc)±3%</b>	51.09	51.29	51.49	51.69	51.89
<b>Short Circuit Current (Isc)±3%</b>	14.23	14.29	14.35	14.41	14.47

<b>Maximum Series Fuse</b>	25	25	25	25	25
----------------------------	----	----	----	----	----

**Electrical Characteristics(NOCT)**

<b>Rated Power (Pmp)</b>	429	432	435	438	441
<b>Power Sorting</b>	0~+5W	0~+5W	0~+5W	0~+5W	0~+5W
<b>Power Tolerance</b>	±3%	±3%	±3%	±3%	±3%
<b>Maximum Power Voltage (Vmp)</b>	39.67	39.81	39.93	40.02	40.11
<b>Maximum Power Current (Imp)</b>	10.79	10.86	10.91	10.96	11.01
<b>Open Circuit Voltage (Voc) ±3%</b>	48.53	48.72	48.91	49.1	49.29
<b>Short Circuit Current (Isc) ±3%</b>	11.48	11.53	11.58	11.63	11.68
<b>Maximum Series Fuse</b>	25	25	25	25	25

**GSM-MT3/132-BTDGXXX(xxx=690-710)**
**Electrical Characteristics(STC)**

<b>Rated Power (Pmp)</b>	690	695	700	705	710
<b>Power Sorting</b>	0~+5W	0~+5W	0~+5W	0~+5W	0~+5W
<b>Power Tolerance</b>	±3%	±3%	±3%	±3%	±3%
<b>Maximum Power Voltage (Vmp)</b>	40.39	40.56	40.71	40.85	41.02
<b>Maximum Power Current (Imp)</b>	17.09	17.14	17.20	17.27	17.32
<b>Open Circuit Voltage (Voc)±3%</b>	47.12	47.26	47.30	47.35	47.40
<b>Short Circuit Current (Isc)±3%</b>	18.12	18.17	18.22	18.26	18.31
<b>Maximum Series Fuse</b>	35	35	35	35	35

**Electrical Characteristics(NOCT)**

<b>Rated Power (Pmp)</b>	526	532	537	542	547
<b>Power Sorting</b>	0~+5W	0~+5W	0~+5W	0~+5W	0~+5W
<b>Power Tolerance</b>	±3%	±3%	±3%	±3%	±3%
<b>Maximum Power Voltage (Vmp)</b>	40.39	40.56	40.71	40.85	41.02
<b>Maximum Power Current (Imp)</b>	13.03	13.12	13.20	13.28	13.35
<b>Open Circuit Voltage (Voc) ±3%</b>	47.12	47.26	47.30	47.35	47.40
<b>Short Circuit Current (Isc) ±3%</b>	13.97	14.07	14.19	14.30	14.41
<b>Maximum Series Fuse</b>	35	35	35	35	35

**GSM-MH2/132-BHDGXXX(xxx=615-635) Electrical Characteristics(STC)**

<b>Rated Power (Pmp)</b>	615	620	625	630	635
<b>Power Sorting</b>	0~+5W	0~+5W	0~+5W	0~+5W	0~+5W
<b>Power Tolerance</b>	±3%	±3%	±3%	±3%	±3%
<b>Maximum Power Voltage (Vmp)</b>	42.16	42.31	42.47	42.63	42.78
<b>Maximum Power Current (Imp)</b>	14.59	14.67	14.73	14.78	14.86
<b>Open Circuit Voltage (Voc)±3%</b>	50.79	50.97	51.15	51.33	51.51
<b>Short Circuit Current (Isc)±3%</b>	15.38	15.43	15.49	15.52	15.58
<b>Maximum Series Fuse</b>	35	35	35	35	35

**Electrical Characteristics(BSTC)**

<b>Rated Power (Pmp)</b>	685	690	695	700	705
<b>Power Sorting</b>	0~+5W	0~+5W	0~+5W	0~+5W	0~+5W
<b>Power Tolerance</b>	±3%	±3%	±3%	±3%	±3%
<b>Maximum Power Voltage (Vmp)</b>	42.14	42.31	42.47	42.63	42.78
<b>Maximum Power Current (Imp)</b>	16.27	16.32	16.37	16.42	16.48
<b>Open Circuit Voltage (Voc) ±3%</b>	50.79	50.97	51.15	51.33	51.51
<b>Short Circuit Current (Isc) ±3%</b>	17.14	17.20	17.24	17.29	17.37
<b>Maximum Series Fuse</b>	35	35	35	35	35

**GSM-MH2/108-BHDGXXX(xxx=500-520) Electrical Characteristics(STC)**

<b>Rated Power (Pmp)</b>	505	510	515	520
<b>Power Sorting</b>	0~+5W	0~+5W	0~+5W	0~+5W
<b>Power Tolerance</b>	±3%	±3%	±3%	±3%
<b>Maximum Power Voltage (Vmp)</b>	34.50	34.61	34.73	34.86
<b>Maximum Power Current (Imp)</b>	14.64	14.75	14.82	14.91

Open Circuit Voltage (Voc)±3%	41.83	41.98	42.13	42.18
Short Circuit Current (Isc)±3%	15.46	15.51	15.56	16.01
Maximum Series Fuse	35	35	35	35

**Electrical Characteristics(BSTC)**

Rated Power (Pmp)	565	570	575	580
Power Sorting	0~+5W	0~+5W	0~+5W	0~+5W
Power Tolerance	±3%	±3%	±3%	±3%
Maximum Power Voltage (Vmp)	34.51	34.61	34.73	34.86
Maximum Power Current (Imp)	16.39	16.47	16.54	16.63
Open Circuit Voltage (Voc) ±3%	41.83	41.98	42.13	42.18
Short Circuit Current (Isc) ±3%	17.23	17.28	17.33	17.85
Maximum Series Fuse	35	35	35	35

**GSM-MH2/96-BHDGXXX(xxx=440-460) Electrical Characteristics(STC)**

Rated Power (Pmp)	445	450	455	460
Power Sorting	0~+5W	0~+5W	0~+5W	0~+5W
Power Tolerance	±3%	±3%	±3%	±3%
Maximum Power Voltage (Vmp)	30.66	30.88	31.10	31.30
Maximum Power Current (Imp)	14.53	14.60	14.66	14.72
Open Circuit Voltage (Voc)±3%	36.49	36.61	36.74	36.87
Short Circuit Current (Isc)±3%	15.65	15.74	15.83	15.92
Maximum Series Fuse	35	35	35	35

**Electrical Characteristics(BSTC)**

Rated Power (Pmp)	495	500	505	510
Power Sorting	0~+5W	0~+5W	0~+5W	0~+5W
Power Tolerance	±3%	±3%	±3%	±3%
Maximum Power Voltage (Vmp)	30.66	30.88	31.10	31.30
Maximum Power Current (Imp)	16.16	16.20	16.25	16.31
Open Circuit Voltage (Voc) ±3%	36.49	36.61	36.74	36.87
Short Circuit Current (Isc) ±3%	17.13	17.19	17.23	17.29
Maximum Series Fuse	35	35	35	35

**GSM-MT2/132-BTDGXXX(xxx=600-620) Electrical Characteristics(STC)**

Rated Power (Pmp)	600	605	610	615	620
Power Sorting	0~+5W	0~+5W	0~+5W	0~+5W	0~+5W
Power Tolerance	±3%	±3%	±3%	±3%	±3%
Maximum Power Voltage (Vmp)	40.04	40.27	40.45	40.63	40.80
Maximum Power Current (Imp)	14.99	15.03	15.09	15.15	15.21
Open Circuit Voltage (Voc)±3%	48.27	48.48	48.70	48.91	49.07
Short Circuit Current (Isc)±3%	15.79	15.85	15.91	15.97	16.05
Maximum Series Fuse	35	35	35	35	35

**Electrical Characteristics(NOCT)**

Rated Power (Pmp)	454	458	462	466	470
Power Sorting	0~+5W	0~+5W	0~+5W	0~+5W	0~+5W
Power Tolerance	±3%	±3%	±3%	±3%	±3%
Maximum Power Voltage (Vmp)	37.21	37.37	37.54	37.70	37.86
Maximum Power Current (Imp)	12.22	12.27	12.32	12.36	12.42
Open Circuit Voltage (Voc) ±3%	44.89	45.09	45.27	45.46	45.63
Short Circuit Current (Isc) ±3%	12.97	13.02	13.05	13.11	13.16
Maximum Series Fuse	35	35	35	35	35

**GSM-MT2/108-BTDGXXX(xxx=490-505) Electrical Characteristics(STC)**

Rated Power (Pmp)	490	495	500	505
Power Sorting	0~+5W	0~+5W	0~+5W	0~+5W
Power Tolerance	±3%	±3%	±3%	±3%
Maximum Power Voltage (Vmp)	32.64	32.86	33.04	33.24

<b>Maximum Power Current (Imp)</b>	15.02	15.06	15.14	15.20
<b>Open Circuit Voltage (Voc)±3%</b>	39.60	39.82	40.01	40.21
<b>Short Circuit Current (Isc)±3%</b>	15.75	15.80	15.89	15.96
<b>Maximum Series Fuse</b>	35	35	35	35

#### Electrical Characteristics(NOCT)

<b>Rated Power (Pmp)</b>	371	375	379	383
<b>Power Sorting</b>	0~+5W	0~+5W	0~+5W	0~+5W
<b>Power Tolerance</b>	±3%	±3%	±3%	±3%
<b>Maximum Power Voltage (Vmp)</b>	30.29	30.47	30.67	30.85
<b>Maximum Power Current (Imp)</b>	12.26	12.29	12.36	12.42
<b>Open Circuit Voltage (Voc) ±3%</b>	36.83	37.01	37.21	37.39
<b>Short Circuit Current (Isc) ±3%</b>	12.92	12.97	13.01	13.09
<b>Maximum Series Fuse</b>	35	35	35	35

#### GSM-MT2/96-BTDGXXX(xxx=435-450) Electrical Characteristics(STC)

<b>Rated Power (Pmp)</b>	435	440	445	450
<b>Power Sorting</b>	0~+5W	0~+5W	0~+5W	0~+5W
<b>Power Tolerance</b>	±3%	±3%	±3%	±3%
<b>Maximum Power Voltage (Vmp)</b>	29.29	29.48	29.69	29.89
<b>Maximum Power Current (Imp)</b>	14.86	14.94	15.01	15.05
<b>Open Circuit Voltage (Voc)±3%</b>	34.76	34.97	35.18	35.39
<b>Short Circuit Current (Isc)±3%</b>	15.91	15.99	16.07	16.15
<b>Maximum Series Fuse</b>	35	35	35	35

#### Electrical Characteristics(NOCT)

<b>Rated Power (Pmp)</b>	330	333	337	341
<b>Power Sorting</b>	0~+5W	0~+5W	0~+5W	0~+5W
<b>Power Tolerance</b>	±3%	±3%	±3%	±3%
<b>Maximum Power Voltage (Vmp)</b>	27.19	27.27	27.57	27.74
<b>Maximum Power Current (Imp)</b>	12.14	12.18	12.22	12.28
<b>Open Circuit Voltage (Voc) ±3%</b>	32.33	32.52	32.74	32.91
<b>Short Circuit Current (Isc) ±3%</b>	13.05	13.11	13.16	13.24
<b>Maximum Series Fuse</b>	35	35	35	35

#### 4.UNPACKING SAFETY 拆包安全

(1) At time of receipt, verify that the product delivered is in fact the product ordered the product name, pallet number, and serial number of each laminate are clearly marked on the outside of each packing box.

收货时，确认发货的产品确实是订购的产品，并在每个包装盒的外面清楚地标明每个托盘的产品名称、托盘号和序列号。

(2) For unpacking outdoors, it is prohibited to operate in rainy conditions. Because the carton will become soft and damaged after it gets wet in the rain. The stacked PV modules (hereinafter referred to as "modules") may tip over, which may cause damage or injury to personnel.

在户外拆包时，禁止在雨中作业。因为外包装纸箱会受潮而变软或者损坏，包装箱里的组件有可能会发生倾斜，倾倒将导致组件损坏以及人员伤害。

(3) For a windy site, it is necessary to pay special attention to safety. Especially, it is not recommended to transport or unpacking the modules in high wind conditions. The unpacked modules must be tied down to avoid any unwanted movement.

在有风的情况下，需要更加关注现场的安全管理，特别是在强风环境下，不建议在这种环境下运输及拆卸组件。已经拆包的组件需要采取恰当的方式固定起来。

(4) The work surface is required to be level to ensure that the package can be placed stably, avoiding sliding.

作业地面需要保证包装箱能够水平稳定的放置，避免倾倒。

(5) Wear protective gloves during unpacking to avoid hand injury and fingerprints on the glass surface.

拆包时，请佩戴劳保手套以避免手受伤，同时确保不会在组件玻璃表面留下手指印。

(6) Each module shall be handled by two persons. It is forbidden to pull the wires or junction boxes and frame of the

modules to carry the module.

每块组件需要2个人抬，抬组件时，禁止拉扯接线盒及边框。

(7) Do NOT use a knife to cut the zip-ties, but use wire cutting pliers.

请勿使用小刀切割扎带，而应使用剪线钳。

(8) Do NOT place modules directly on top of each other.

不要将组件直接叠放在一起。



## 5、INSTALLATION 安装

### 5.1、INSTALLATION SAFETY 安装安全

(1) Always wear dry insulation protection equipment: insulated tools, head gear, insulated gloves, safety belt and safety shoes (with rubber soles).

请使用干燥的绝缘防护措施：如绝缘工具、安全帽、绝缘手套、安全带和安全鞋（橡胶底）。

(2) Make sure flammable gasses are not generated or present near the installation site.

请确保安装地点附近，不会有或者不会产生可燃性气体。

(3) Do not install modules under rain, snow or windy conditions. Place disassembled PV modules correctly.

请勿在下雨、下雪或大风的情况下安装组件，并将已拆包组件进行妥善安置。

(4) Keep the PV module packed in the carton until installation. Please install immediately after unpacking. Please keep the connector dry and clean during installation to avoid the risk of electric shock. Do not perform any work if the terminals of PV module are wet, until they are dry.

安装的时候再把组件拆包。请在开箱后立即安装，安装时请保持连接器干燥清洁，以免触电风险。如果光伏组件的连接器端子潮湿则禁止安装，直至干燥后方可安装。

(5) Please take measures to insulate during PV module installation and wiring. Do not unplug the connector if the system circuit is connected to a load.

在光伏组件安装和布线期间，必须进行绝缘防护。如果系统电路与负载接通，请不要拔下连接插头。

(6) Do not touch the junction box and the end of the interconnect cables (connectors) with bare hands during installation or under sunlight, regardless if the PV module is connected to or disconnected from the system.

不管组件有没有连接到光伏系统，在安装过程或者是有光照照在组件上的时候，请不要裸手接触接线盒或者公母接头。

(7) During installation, if PV modules are touched by bare hands, there is a risk of scalding or electric shock.

在安装过程中，避免裸手触摸组件，会有烫伤或者电击的危险。

(8) Do not hit or put excessive load on the front or back of PV modules, this may break the cells or cause microcracks.

不要在组件的正面或背面放过重的物体或者进行撞击，这可能会损坏电池片或者造成电池片隐裂。

(9) Make sure that the polarity of each module or a string is not reversed considering the rest of the modules or strings.

考虑到其他组件或串，请确保每个组件或串的极性没有颠倒。

(10) Do not stand on the module glass. There is a risk of injury or electric shock if glass is broken. Do not work alone (always work as a team of 2 or more people).

不要站在玻璃上，以免玻璃破碎造成伤害或引发触电危险。不要单独工作（一直保持由2个或更多的人组成团队工作）

(11) Ensure sure that all connections are securely made with no gap between the contacts. Any gap can result in electrical arcing that can cause a fire hazard and/or an electric shock.

确保所有连接牢固，触点之间无缝隙。任何缝隙都可能导致电弧，从而导致火灾和/或触电危险。

(12) Do not damage the back sheet of PV modules when fastening the PV modules to a support with bolts.

在通过螺栓将光伏组件紧固到支架上时，不要损坏光伏组件的背板。

(13) Do not drill holes in the frame. It may cause corrosion of the frame or PV modules burst.

不要擅自在组件的边框上进行钻孔，可能会引起边框腐蚀以及组件爆裂。

(14) Do not damage the surrounding PV modules or mounting structure when replacing a PV module.

更换光伏组件时，不要损坏周围的光伏组件或安装结构。

(15) Cables should be fixed in the area not exposed to direct sunlight to prevent cables aging.

电缆应固定在不受阳光直射区域，防止电缆老化。

(16) Protective measures must be taken in the process of installation to avoid force extrusion or impact on the modules.

安装时采取防护措施，以避免组件受到外力挤压或撞击。

(17) When installing modules on roof mounted structures, please try to follow the “from top to bottom” and/or “from left to right” principle, and don’t step on the module. This will damage the module and would be dangerous for personal safety.

对于BIPV或是安装在屋顶的结构，请尽量遵循“从上到下”和/或“从左到右”的安全原则，请不要站到组件上面去，因为那样会损坏组件，也会对人身安全造成危险。

(18) The design loading of modules have been evaluated by TUV according to IEC61215 with 1.5 times safety factor; The mechanical load bearing is dependent upon the mounting methods used and failure to follow the instructions of this manual may result in different capabilities to withstand snow and wind loads;The system installer must ensure that the installation methods used meet these requirements and any local codes and regulations.

根据 IEC61215,TUV已经对组件进行了设计载荷评估,安全系数1.5倍;机械承载取决于所用的安装方法,未能遵循本手册说明可能会导致承受雪和风荷载的变化。系统安装人员必须确保所使用的安装方法符合这些要求和任何当地的法律法规。

(19) We recommend that you insure your Solar system against natural hazards (e.g. against lightning strikes).

我们建议你为你的太阳系统投保以防止自然灾害(例如雷击)。

(20) Grand Sunergy modules are certified to be installed and operated in safety level II at voltages lower than 1500Vdc.This maximum voltage should not be exceeded at any time and, as the voltage of the module increases, above data sheet values, at operating temperatures below 25°C, then these need to be taken into account when designing a PV system.

国晟科技组件经认证,可在低于 1500Vdc 的电压下安装和操作安全级别II。在任何时候都不应超过此最大电压,并且随着组件电压的增加,高于数据表值,工作温度低于 25°C,则在设计 PV 系统时需要考虑这些。

(21) Under normal conditions, a solar photovoltaic module is likely to produce more current and /or voltage than reported under standard test conditions. Accordingly, the value of Isc marked on this module should be multiplied by a factor of 1.25 when determining the conductor current ratings, fuse sizes and size of controls connected to the SPV output.

在正常情况下,太阳能光伏组件可能产生比标准测试条件下报告的更多的电流和/或电压。因此,当决定导体电流额定值、熔断器尺寸和连接到SPV输出的控制的尺寸时,在这个组件上标记的Isc值应乘以1.25的因子。

(22) Do not install modules in a location where they will be immersed in or continually exposed to water.

请勿将组件安装在会浸入或持续暴露于水中的位置。

## 5.2、ENVIRONMENT CONDITIONS AND SITE SELECTION 环境条件与安装地址选择

Grand Sunergy solar module should be installed in the following environmental conditions.

适用于国晟太阳能光伏组件安装的环境条件如下:

**Table 5-1 operation condition**

**表5-1 组件操作和工作环境**

NO 序号	Environmental conditions 环境条件	Range 范围
1	Recommended Working temperature 推荐工作环境温度	-40°C~+40°C
2	Storage temperature 存储温度	-20°C~+50°C
3	Humidity 湿度	5≤RH%≤95

**Remarks:** The working environment temperature is the monthly average maximum temperature and minimum temperature of the installation site. The mechanical load bearing capacity of the Solar PV modules determined based on the installation method. Mechanical Load Pressure: The design pressure is 3600 (front)/1600 (back) and the safety factor is 1.5.

备注:该工作环境温度为安装地点月平均最高温度和最低温度。太阳能光伏组件所能承受的机械载荷是由安装方式来决定,机械负载压力:设计压力为3600(前)/1600(后),安全系数为1.5。

Notes:

- The mechanical load bearing is dependent upon the mounting methods used and failure to follow the instructions of this manual may result in different capabilities to withstand snow and wind loads. The system installer must ensure that the installation methods used meet these requirements and any local codes and regulations.

注释:

机械承重取决于所使用的安装方法,如果不遵循本手册的说明,可能会导致承受雪和风载荷的能力不同。系统安装人员必须确保所使用的安装方法符合这些要求以及任何当地法规和规定。

If you are planning to use the PV modules where the water damage (Humidity: > 85RH%) may be possible, please consult with Grand Sunergy technical support firstly to determine an appropriate installation method, or to determine whether the installation is possible.

如果您计划在可能出现水渍侵害的地方（湿度： $>85RH\%$ ）使用光伏组件，请先向国晟科技的技术支持团队咨询以确定合适的安装方法，或确定是否可以安装。

The operator needs to consider the effect of the high altitude on the operation of the module, when the modules are installed at high altitude. The maximum altitude allowed for PV Module installation is 2000m.

当组件安装在高空时，操作者需要考虑高空对组件运行的影响。光伏组件允许安装的最大海拔为2000米。

For most places, Grand Sunergy PV modules should be installed where the sunlight can be maximally acquired throughout the year. In the Northern Hemisphere, the PV modules should typically face south, and in the Southern Hemisphere, the PV modules should typically face north.

对于大多数地方，国晟科技太阳能光伏组件应该被安装在全年内能够最大限度接受阳光照射的地方。在北半球安装，组件最好朝南，在南半球安装，组件最好朝北。

When selecting the installation location, avoid areas with trees, buildings, or obstacles because these objects will form shadows on Solar PV modules, especially when the sun is at the lowest position on the horizon in winter. The shadow will cause the loss of the output power of the Solar photovoltaic system. Although the bypass diode installed in the PV module can reduce this loss to some extent, do not ignore the shadow factor.

选择安装位置时，避免有树木、建筑物或者是障碍物的区域，因为这些物体会在太阳能光伏组件上形成阴影，尤其是在冬季当太阳光处于地平线上最低的位置时。阴影会造成太阳能光伏系统输出功率的损失，尽管太阳能光伏组件装有的旁路二极管可以一定限度的减少这种损失，也不要忽视阴影的因素。

Position the modules to minimize the chances of shading at all times of the day. Try to install modules in a location where there is rare shading throughout the year. Shading can normally be minimized by ensuring that the distance between the obstruction and solar array is greater than three times the obstruction's height.

对组件进行定位以尽量减少其在一天中任何时间段遮光的可能性。尽量将组件安装在一年中罕有遮阳的位置。通常可以通过确保障碍物和太阳能电池阵列之间的距离大于障碍物高度的三倍来最小化阴影。

The module must not be soaked in the water or in the environment (i.e., fountain, spindrift, etc.) where the module would touch water (pure water or brine) for a long term. If the modules are placed in an environment of salt fog (i.e., marine environment) or sulfur (i.e., sulfur sources, volcanoes, etc.), there is a risk of corrosion. It's not recommended to install the modules, when the distance is less than 100m ; and it's recommended to install the modules with the anti-salt function, when the distance is between 100m and 1km. So stainless steel or aluminum materials must be used to contact the PV modules, and the installation position must be processed with anti-corrosion treatment.

组件不得浸泡在水中或长期沾水(纯水或盐水)的环境中(例如喷泉、浪花等)。如果组件置于盐雾(即海洋性环境)或者含硫(即含硫源、火山等)的环境中，会有腐蚀的风险。当距离小于100m时，不建议安装组件；当距离在100m~1km之间时，建议安装具有防盐雾功能的组件。必须采用不锈钢或者铝材料来与光伏组件接触，并且对安装部位做好防锈蚀的处理。

According to the surrounding environment of the project, use the appropriate protective measures to ensure the safety of the module installation and reliable. For example, it needs to have around the windproof measures like design of windbreaks in strong wind area.

根据项目地的周围环境，采用合适的保护措施确保组件安装的载荷可靠和安全，如强风区域，周围需要有防风措施如设计防风林。

The system design needs to have the lightning protection function, it must pay more attention especially in the installation ground where are more lightning strike.

系统设计需要有防雷击功能，特别是在安装地有较多雷击，一定要更加重视。

When installing Solar modules on a roof, the roof must be covered with a layer of fireproof material applicable to this class, and adequate ventilation must be ensured between the back of the module and the installation surface. A safe working area also must be left between the edge of the roof and the external edge of the Solar array.

当在屋顶上安装太阳能组件时，屋顶上必须要覆盖有一层适用于该等级的防火材料，并且保证组件背面和安装面之间充分的通风，要在屋顶边缘和太阳能阵列的外边缘之间留出安全的工作区域。

In the case of residential installations on the ground, modules must be installed following local regulations, e.g. using fence.

如果住宅设施在地面上，组件的安装应按照当地法规进行，例如安装中需要用到围栏。

Grand Sunergy Modules can be mounted in landscape and portrait orientation however the impact of dirt shading the solar cells can be minimized by orienting the product in portrait.

国晟科技组件可以横向和纵向安装，但是通过纵向放置产品可以最大限度地减少灰尘遮蔽太阳能电池的影响。

Avoid using a mounting method that will block the drainage holes in the module frame.

避免使用会堵塞组件框架排水孔的安装方法。

### 5.3、TILT ANGLE OF INSTALLATION 光伏组件安装倾角

The installation of Solar PV module string should be in the same orientation and the same installation angle. Different installation directions and installation angles will lead to the mismatches in current and voltage which is caused by different light absorption of different Solar modules, this mismatch will cause the PV system power output loss.

太阳能光伏组件串的安装应该保持同一方位和同一安装角度。不同的安装方位和安装倾角会导致不同的太阳能光伏组件串吸收光线总量存在差异而导致的产生的电流和电压不匹配，从而降低系统运行效率，造成功率输出损失。

When all solar modules are mounted in the same plane and orientation then all can be expected to have similar performance throughout the day and can be connected together to the same inverter channel.

当所有太阳能组件安装在同一平面和方向上时，所有组件都有望在全天具有相似的性能，并且可以连接到同一个逆变器通道。

If solar modules on the same installation are mounted at different angles or orientations then energy production can normally be optimized by connecting the different orientations to different inverters (or different MPPT if the inverter has more than one MPPT). Refer to inverter manufacturers for further guidelines.

如果同一装置上的太阳能组件以不同的角度或方向安装，通常可以通过将不同的方向连接到不同的逆变器（如果逆变器有多个 MPPT，则连接不同的 MPPT）来优化能源生产。请参阅逆变器制造商了解更多指南。

The largest power will be generated When direct sunlight on Solar PV module. For modules which are installed on the fixed brackets, the best installation angle should be selected to ensure the maximum power output can be generated at winter time, if the angle can guarantee enough power output during the winter, it will make the whole Solar PV system in the rest of the year can have enough power output also.

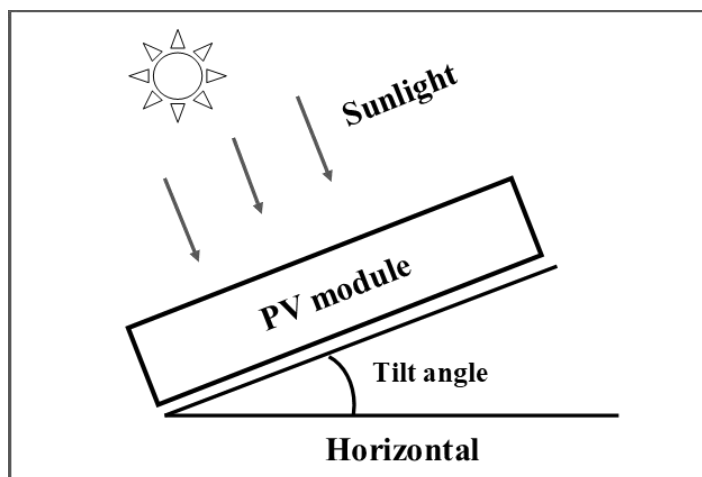
当阳光直射到太阳能光伏组件上时产生的功率最大，对于那些安装在固定支架上的太阳能光伏组件，选择最佳的安装倾角时应考虑冬季的太阳能光伏组件的功率产出，如果该角度能保证光伏组件在冬季有足够的功率输出，那将会使整个太阳能光伏组件体系在一年中的余下时间里也能有足够的功率产出。

Solar modules are recommended to be installed at an optimized tilt angle to maximize the energy output. For detailed information on the best installation angle, please refer to standard Solar photovoltaic installation guides or consult a reputable Solar installer or systems integrator. Dust building up on the surface of the modules can impair module performance. YuHuan Sunpro Solar recommends installing the modules with a tilt angle of at least 10°, making it easier for dust to be washed off by rain. Any faults caused by and/or attributable to tilt angle less than 10 degrees are not covered by manufacturer's warranty. It is roughly equal to the latitude of the project site as a rule of thumb, facing toward the equator. Optimized system designs must incorporate other local requirements.

建议通过优化的倾斜角安装太阳能组件以达到能量输出最大化。对于详细的安装角度，请依据标准组件安装指南或者有经验的光伏组件安装商给出的建议。国晟建议组件安装的时候安装夹角不小于10°，这样组件在下雨的时候表面灰尘容易被雨水带走，从而减小组件清洗次数，同时利于组件表面的积水流走，避免长期大量积水在玻璃上留下痕迹，进而影响组件外观性能。任何由倾斜角度小于10度引起的故障不包括在制造商的保修范围内。一般来说它大致等同于项目所在地的纬度，面向赤道方向。但在实际的设计中还是按照当地具体情况设计并找出最佳倾斜角。

Installation inclination refers to the Angle between the PV module and the ground plane, as shown in Figure 5-1.

安装倾角是指太阳能光伏组件与水平面之间的角度，如图5-1所示。



**Fig. 5-1 Tilt angle**

**图5-1 安装倾角示意图**

**Table 5-2 Recommended tilt angle for fixed systems**

**表5-2 固定系统安装时建议的安装倾角**

安装地所处纬度 Latitude	安装倾角 Tilt angle
0°~15°	15°
15°~25°	The same latitude 同安装地所处纬度
25°~30°	Same latitude +5° 安装地所处纬度+5°
30°~35°	Same latitude +10° 安装地所处纬度+10°
35°~40°	Same latitude +15° 安装地所处纬度+15°
40°+	Same latitude +20° 安装地所处纬度+20°

#### **5.4. INSTALLATION REQUIREMENTS FOR BIFACIAL CELLS MODULE 双面电池组件安装要求**

Under the certain installation conditions, the backside of bifacial cells module will also generate electricity power after receiving the reflected light, which will bring additional power generation gain to the power station system.

双面电池组件在一定的安装条件下，背面接受到反射光后也会发电，会给电站系统带来额外的发电增益。

The shading on the module surface will affect the power generation much, the module should be installed in the place where the module cannot be shadowed totally (such as the shadow from building, chimney and tree etc.), and even the partially shading (such as the dirt, snow and aerial wire etc.) should be avoided.

组件应在整年完全不被（阴影）遮挡（例如，通过建筑、烟囱、树），即便部分（阴影）遮挡（例如，通过架空线、污垢、雪、背面支架）也应避免。

The generation gain is related to the ground reflectivity, the module installation height to the ground, the array spacing and the shadow shading to the module backside.

发电量增益和地面反射率、组件离地高度、阵列间距和背面阴影遮挡有关。

Generally speaking, the reflectance is various with the different ground (See table 5-3), and this will lead to different power generation gain.

一般来说，不同的地面其反射率是不一样的，由此带来的组件发电增益也不同。如表5-3所示。

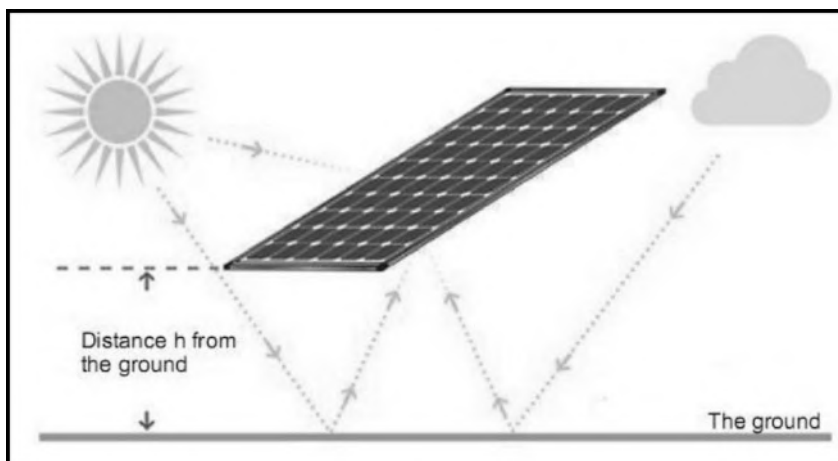
**Table 5-3 reflectivity of different surfaces**

**表5-3 不同地面的反射率**

The ground type 地面类型	Water 水面	Grassland 草地	Ground 土地	Concrete 混凝土	Sand 沙地	Snow 雪地
Reflectivity range (%) 反射率范围	5-12	12-25	20-33	20-40	20-40	80-85

Due to the different ground clearance height will affect the power generation gain, it is recommended to install the module at a height from 0.5m to 2m. See Fig. 5-2.

不同离地高度也会影响双面电池组件发电量的增益，一般建议安装高度为0.5m~2m比较合适。如图5-2所示。


**Fig. 5-2 Distance from the earth**
**图5-2 双面电池组件安装离地**

In the system design, besides the ground type and the module installation height to ground, the proper array spacing and how to avoid shadow shading on the back need to be considered too, please consult with the professional system designer.

在进行系统设计时，除了地面类型和离地高度以外，合适的阵列间距与如何避免背面阴影遮挡都需要考虑，请咨询专业系统设计人员。

## 5.5、INSTALLATION METHOD 安装方法

### 5.5.1 MECHANICAL INSTALLATION AND WARNING 机械安装及注意事项

PV modules can be installed through clamp method. The modules must be installed according to the following examples and recommendations. If a different installation method is desired, please contact Grand Sunergy customer service or technical support team for consultation. Improperly mounted modules maybe damaged. If alternative mounting method is used that has not been approved by Grand Sunergy, the modules will not continue to carry a valid warranty.

光伏组件的固定和安装可以采用压块固定方式。安装组件必须依照下面示例和建议进行，如果安装方式与国晟科技公示不同，请咨询国晟科技技术支持或售后，并取得国晟科技同意，否则会损坏组件并导致质保失效。

Modules shall not be subjected to wind or snow loads which is exceeding the maximum permissible designed loads, and shall not be subjected to excessive forces due to the thermal expansion of the support structures. The selection and design of mounting bracket shall be carried out by professional system engineers after the load calculation according to the climatic conditions of the installation site.

系统设计过程中光伏组件不应承受任何超出最大设计载荷的负荷（如风和雪载荷），同时不应该承受因支架结构的热膨胀而产生的过大的力。根据安装地气候条件由专业系统工程师进行载荷计算，然后对安装支架进行选择和设计。

The modules depicted are mounted on continuous rails that extend beneath the modules. If modules are mounted without continuous rails below them, the maximum allowable loading will be reduced and needs to be subjected to review.

所描述的组件被安装在组件下方延伸的连续支架上。如果组件被安装在没有连续的支架的情况下，那么最大的允许载荷将会减少，需进行检查。

Please ensure that the modules with the same color cells to be installed together.

在组件安装过程中，建议使用相同色系的组件安装在一起。

A clearance of at least 115mm (recommended) is provided between modules and the surface of the wall or roof.

建议在组件和墙面或屋顶表面之间留有至少115mm的间隙。

The minimum clearance between two adjacent modules must not be less than 10mm.

两块相邻组件之间的最小间隙不能小于10mm。

The module frame drain holes cannot be blocked in any situation during installation or use.

安装或使用过程中，排水孔在任何情况下都不能堵塞。

To maximize mounting longevity, Grand Sunergy strongly recommends the use of corrosion proof (stainless steel) attachment hardware.

为最大程度的延长安装寿命，国晟科技 建议使用防腐蚀（不锈钢）固件。

The installation method listed below are for your reference only, the PV system installer or the trained professionals should take the responsibility of the PV system design, mechanical load calculation, install, maintenance and safety, Grand Sunergy will not supply the related material for system installation.

以下列出的安装方法仅供参考，系统安装商或经过训练的专业人士必须对光伏系统的设计，机械载荷计算、安装、保养和安全负责，国晟科技不提供相关的安装材料。

### (1) Screw Installation

Each PV module has 8 mounting holes (shown as drawing 1).The downward mechanical load resistance of module would be different according to the installation holes used(shown as table 1),Please use 8 of them to secure the modules to support structure. The module frame must be attached to a mounting rail using M8 corrosion-proof screws together with spring washers and flat washers in eight symmetrical locations on the PV module. The applied torque should be big enough to fix it steadily. The reference torque value for M8 screw is 16~20N\*m.

#### (1)螺钉安装

每个光伏组件有8个安装孔(如图1所示)，不同的安装孔，组件向下的机械载荷抗力不同(如表1所示)，请使用8个安装孔将组件固定在支撑结构上。组件框必须用M8防腐蚀螺钉固定在安装轨上，并在光伏组件的8个对称位置使用弹垫和平垫固定。施加的扭矩应该足够大，可以稳定地固定它。M8螺杆的参考扭矩值为16~20N\*m


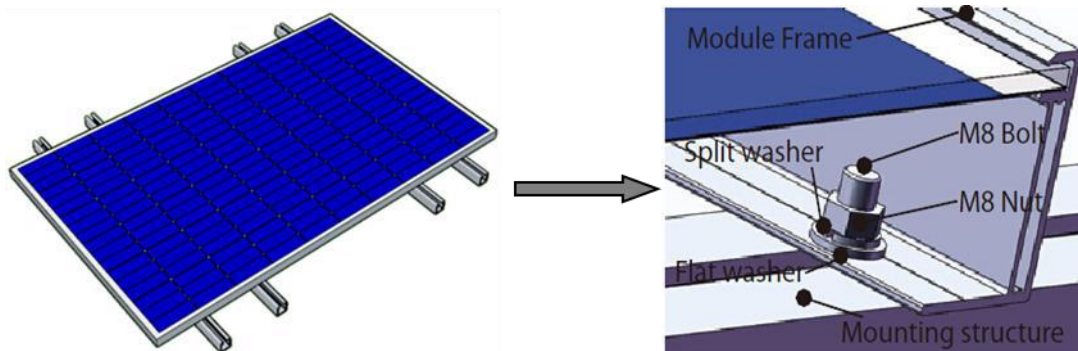
5400Pa Load Tested	
Mounting system	

Table 1



Drawing 1

## (2) Clamp Installation

The modules can be fixed on both the long and the short side of the module within the constraints shown in drawing 2, using a minimum of four clamps. The modules are built to withstand a downward force of up to 5400 Pa (550 kg/m<sup>2</sup>) or 2400 Pa (244 kg/m<sup>2</sup>) according to where they are clamped. Site-specific loads such as wind or snow which may exert forces in a different way need to be taken into consideration to ensure this limit is not exceeded for each respective mounting option.

### (2)压块安装

在图2所示的约束条件下，压块可以固定在组件的长边和短边上，使用最少4个压块。根据其固定位置，组件可承受高达5400 Pa (550 kg/m<sup>2</sup>)或2400 Pa (244 kg/m<sup>2</sup>)的向下力。需要考虑现场特定的载荷，如风或雪，它们可能以不同的方式施加力，以确保每个安装选项不超过这个限制。

#### A. For standard module with backsheet: 单玻标准组件

1. Clamp picture as below:

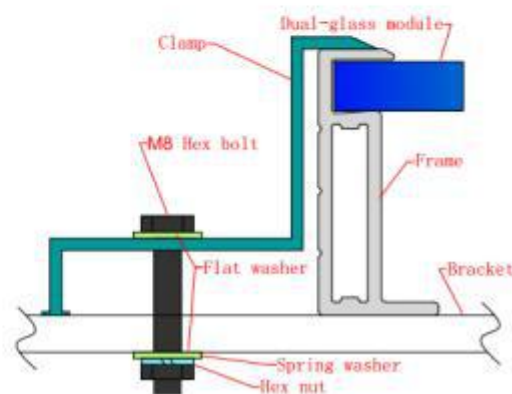
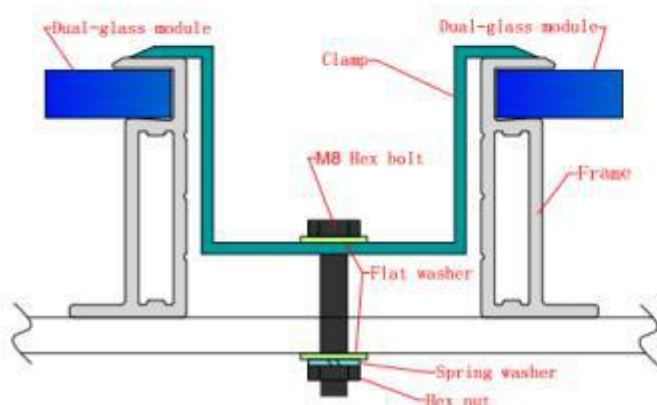
1. 压块图片如下:



Figure 3 Double-side clamp

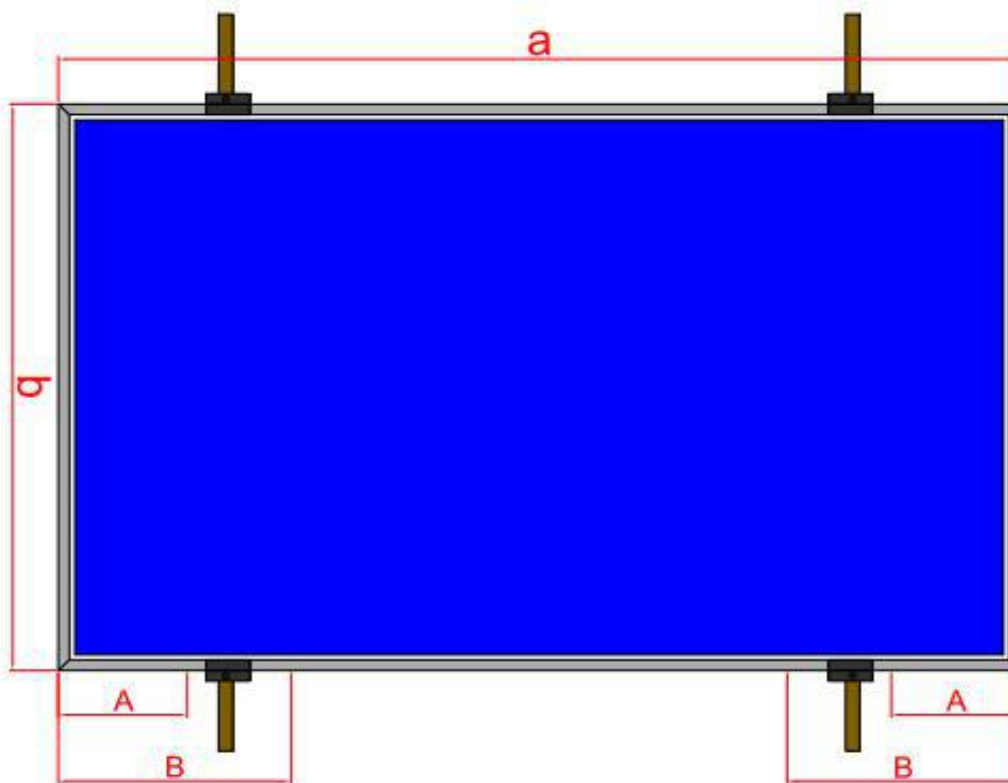


Figure 4 Single-side clamp





## 2. Install module with clamps at long sides of frames 在框架的长边用压块安装组件



This Installation method is applicable to the series of PV modules as listed below:

本安装方法适用于以下光伏组件系列:

Table 1

Type 1	GSM-MP3/132-MXXX
Type 2	GSM-MP3/120-MXXX
Type 3	GSM-MP4/156-MXXX
Type 4	GSM-MP4/144-MXXX
Type 5	GSM-MP4/132-MXXX
Type 6	GSM-MP4/120-MXXX
Type 7	GSM-MP4/108-MXXX
Type 8	GSM-MP4/144-MBXXX
Type 9	GSM-MP4/120-MBXXX
Type 10	GSM-MP4/108-MBXXX

NOTE : XXX : Module power

### B.For dual glass module with frame 双玻组件

The dual glass module with frame is designed for clamp installation. It needs the clamps, bolts, nuts and washers to fix on the bracket (as shown in figure1, 2, 3, 4). Sufficient torque should be applied to the bolts to ensure stable reinforcement. The reference torque value for M8 screw is 16~20N\*M.

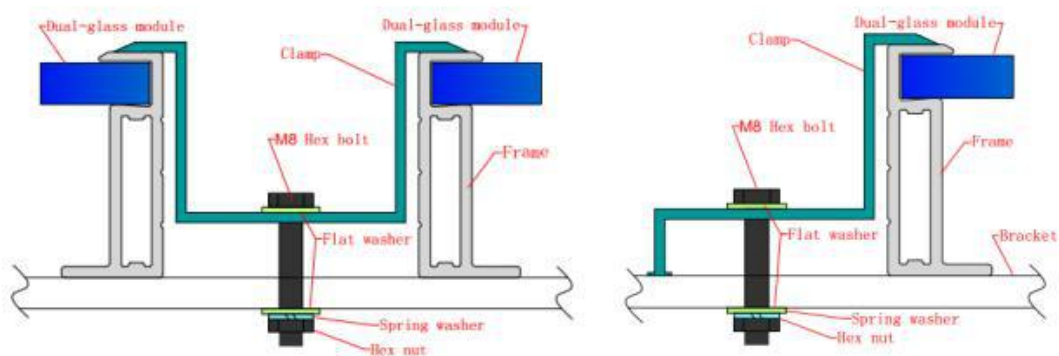
双框组件设计为压块安装。需要用压块、螺栓、螺母和垫圈固定在支架上(如图1、2、3、4所示)。螺栓要施加足够的扭矩,确保加固稳定。M8螺杆的参考扭矩值为16~20N\*M。



Figure 3 Double-side clamp



Figure 4 Single-side clamp



This Installation method is applicable to the series of PV modules as listed below:

本安装方法适用于以下光伏组件系列:

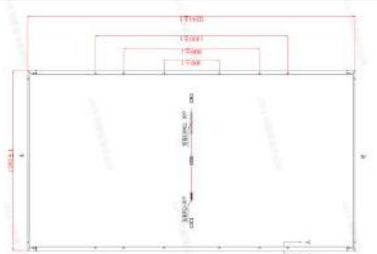
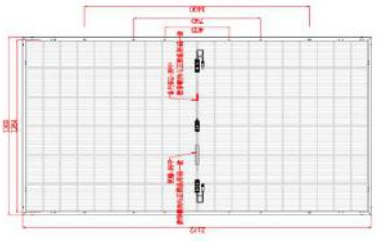
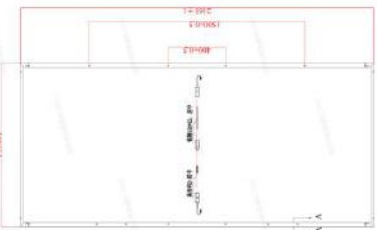

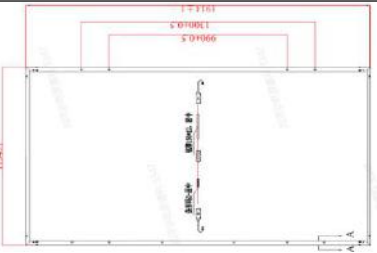
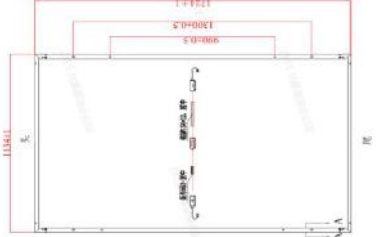
Table 2

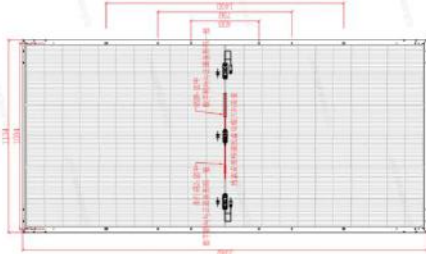
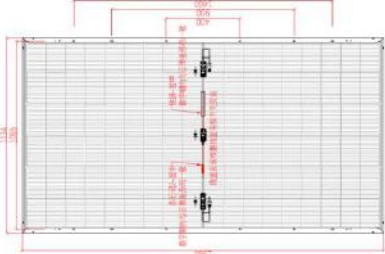
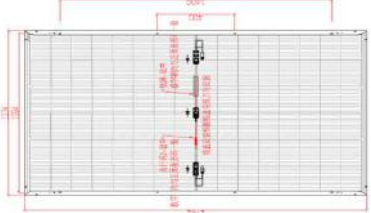
Type 1	GSM-MP3/132-BMDGXXX	Type 12	GSM-MH2/108-BHDGXXX
Type 2	GSM-MP3/120-BMDGXXX	Type 13	GSM-MH2/96-BHDGXXX
Type 3	GSM-MP4/144-BMDGXXX	Type 14	GSM-MH2/96-BHDGXXX
Type 4	GSM-MP4/120-BMDGXXX	Type 15	GSM-MT3/132-BTDGXXX
Type 5	GSM-MP4/108-BMDGXXX	Type 16	GSM-MT3/120-BTDGXXX
Type 6	GSM-MH3/132-BHDGXXX	Type 17	GSM-MT4/144-BTDGXXX
Type 7	GSM-MH3/120-BHDGXXX	Type 18	GSM-MT4/120-BTDGXXX
Type 8	GSM-MH4/156-BHDGXXX	Type 19	GSM-MT4/108-BTDGXXX
Type 9	GSM-MH4/144-BHDGXXX	Type 20	GSM-MT2/132-BTDGXXX
Type 10	GSM-MH4/120-BHDGXXX	Type 21	GSM-MT2/108-BTDGXXX
Type 11	GSM-MH4/108-BHDGXXX	Type 22	GSM-MT2/96BTDGXXX

The selection and installation of the clamps shall obey the requirement according to table 3. Otherwise the module may not satisfy the mechanical load and have the risk of broken.

压块的选择和安装应按表3要求进行。否则，组件可能无法满足机械载荷，并有破碎的风险。

Table 3

Type	Loads (Pa)	Clamp Length (压块长度)	Installation Drawing (示意图)	Notes
1	5400/2400	≥50mm		<b>Size(module): 2384*1303*33mm</b> <b>Distance between holes: 1400mm/990mm/400mm</b>
2	5400/2400	≥50mm		<b>Size(module): 2172*1303*33mm</b> <b>Distance between holes: 1400mm/790mm/400mm</b>
3	5400/2400	≥50mm		<b>Size(module): 2465*1134*30mm</b> <b>Distance between holes: 1500mm/400mm</b>
4	5400/2400	≥50mm		<b>Size(module): 2278*1134*30mm</b> <b>Distance between holes: 1400mm/990mm/400mm</b>
5	5400/2400	≥50mm		<b>Size(module): 1914*1134*30mm</b> <b>Distance between holes: 1300mm/990mm</b>
6	5400/2400	≥50mm		<b>Size(module): 1722*1134*30mm</b> <b>Distance between holes: 1300mm/990mm</b>

7	5400/2400	≥50mm		<b>Size(module): 2382*1134*30mm</b> <b>Distance between holes:</b> <b>1400mm/790mm/400mm</b>
8	5400/2400	≥50mm		<b>Size(module): 1960*1134*30mm</b> <b>Distance between holes:</b> <b>1400mm/990mm/400mm</b>
9	5400/2400	≥50mm		<b>Size(module): 1762*1134*30mm</b> <b>Distance between holes:</b> <b>1400mm/400mm</b>

**. \*NOTES:**

Other mounting configurations can be used. However, failure to comply with the above recommendations will result in a lowering of the load handling capabilities below the empirical value, and product failure as a result of an overload situation will not be covered by the Grand Sunergy warranty.

注意：可以使用其他安装配置，但不遵守上述建议将会导致组件载荷能力低于经验值，产品因过载失败不会享受国晟质保。

## 5.5.2 ELECTRICAL INSTALLATION 电气安装

### 1、Cable layout 布线方式

The recommended vertical installation connection methods for module with split J-Box are as follows (The extension cable is required).

推荐竖装连线方案示意图如下（需要延长电缆线）。

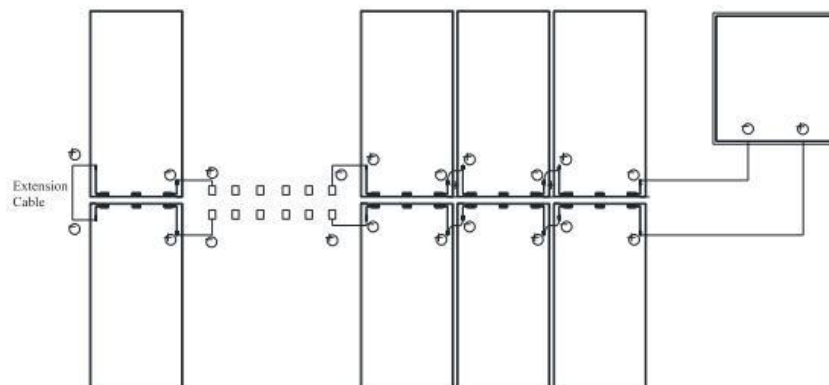


Fig.1 Split J-Box at module side position for vertical direction

图1 接线盒在边缘的垂直安装方式

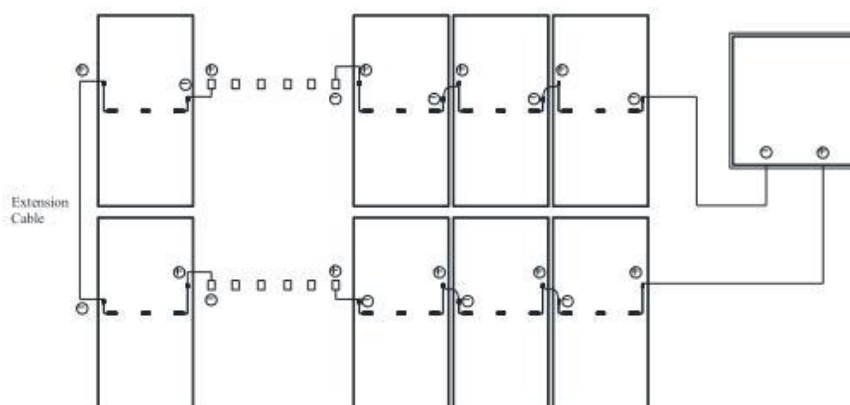


Fig.2 Split J-Box at module middle position for vertical direction

图2 接线盒在中间的垂直安装方式

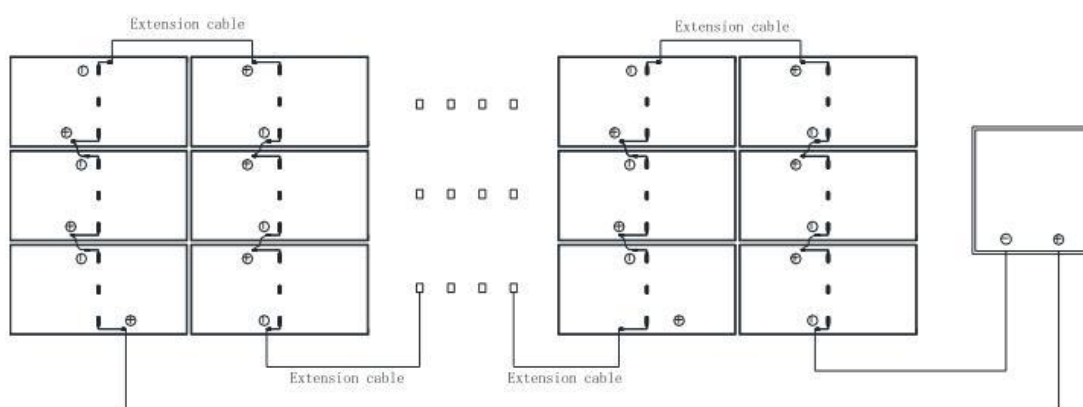


Fig.3 Split J-Box at module middle position for horizontal direction

图3 接线盒在中间的水平安装方式

**Precautions:** To minimize risk in the event of an indirect lightning strike, avoid forming loops when designing the system. In order to avoid bad or damaged connection of the cable and connector, the cable and junction box caused by human factors, affecting the electrical safety or service life of the product, it is recommended that the force applied between the cable and connector, cable and junction box shall not be greater than 60N during the installation, dismantling, maintenance and any other related process of the Product.

**安装需注意事项：**为了将间接雷击的风险降到最低，在设计系统时应避免形成回路。为避免人为因素造成线缆与连接器、线缆与接线盒连接不良或损坏，影响产品电气安全或使用寿命，建议产品在安装、拆卸、维护及任何其它相关过程中，施加在线缆和连接器、线缆和接线盒之间的作用力不得大于60N。

Pay attention to the direction of the wire when installing the modules. It should be connected along the wire direction to avoid bending the wire.

注意组件安装时的导线方向，应顺着导线方向连接，避免导线折弯。

## 2、Electrical Connection 连接

The Direct Current (DC) generated by the PV system can be converted to Alternating Current (AC) and connected to the public power grid. Different regions may have different policies, laws and regulations to stipulate the installation and grid-connection requirements of PV systems. Therefore, during the design, installation and grid-connection of PV system, please comply with the local policies, laws and regulations.

光伏系统产生的直流电可以转换成交流电，并与公共电网相连。不同地区可能有不同的政策和法律法规来规定光伏系统的安装要求和并网要求，因此在光伏系统的设计、安装和并网过程中，请遵守当地的政策和法律法规要求。

PV modules can obtain different current and voltage outputs through series connection and parallel connection. Read this installation manual carefully before electrical connection and installation. Please design and connect according to the current and voltage required by customers. Before connection, please ensure that the connection part is free from corrosion, and keep it clean and dry.

光伏组件通过串联和并联的连接方式可以获得不同的电流和电压输出，在进行电气连接和安装前，请仔细阅读本安装手册，并依据客户所要求的电流和电压进行设计和连线。连接前请确保连接部分无腐蚀，保持清洁和干燥。

Different types of modules cannot be connected in series. Modules connected in series should ensure the consistency of their current. The voltage of the module string should not exceed the allowable system voltage value, which can be found on the nameplate or datasheet of the module.

不同类型的组件产品不能串联在一起，串联在一起的组件产品要保证其电流的一致性，组件串的电压不能超过所允许的组件系统电压值，该电压值可以在组件的铭牌或者规格书里找到。

Grand Sunergy modules are provided with stranded copper cables with a cross sectional area of 4mm<sup>2</sup> which are rated for 1500V dc, connectors with rated current greater than 15A, and are UV resistant. All other cables used to connect the DC system should have a similar (or better) specification. Grand Sunergy recommend that all cables are run in appropriate conduits and sited away from areas prone to water collection. The connector should be mated with its original female or male connector of the same supplier

国晟科技组件提供横截面积为 4mm<sup>2</sup> 的铜绞线，额定电压为 1500V dc，连接器为额定电流大于15A，，抗紫外线。用于连接直流系统的所有其他电缆都应具有类似（或更好）的规格。国晟科技建议将所有电缆铺设在适当的导管中，并远离容易积水的区域。连接器应与同一供应商的原始母头或公头连接器配对。

The maximum number of modules in series depends on the system design, the type of converter used and the environmental conditions. In general, the maximum number (N) of PV modules in series can be calculated by dividing the maximum system voltage by the open circuit voltage of the relevant Solar PV modules. When designing the Solar PV system, it is necessary to take into account the characteristic that the voltage of the Solar PV module changes with the temperature. Considering the voltage increase caused by temperature drop in extreme environment in winter, the maximum series connection number of Solar PV modules can be calculated by the following formula.

串联组件的最大数目取决于系统设计、所用变频器的类型和环境条件。通常情况下，最大的串联太阳能光伏组件数量（N）可以通过系统最大电压除以相关太阳能光伏组件开路电压的方式计算而获得，但是在设计太阳能光伏系统时，一定要考虑到太阳能光伏组件的电压随着温度变化而变化的特性。考虑到冬季里极端环境下温度下降造成的电压升高，太阳能光伏组件最大串联数量可以使用以下公式计算：

**Table 5-4 maximum series connection number calculation**

**Table 5-4 串联最大数量计算**

<b>Formula</b>	Maximum system voltage $V \geq N * V_{oc} * [1 + \beta * (T_{min} - 25)]$
<b>公式</b>	最大系统电压 $V \geq N * V_{oc} * [1 + \beta * (T_{min} - 25)]$

<b>V</b>	Maximum system voltage 最大系统电压
<b>N</b>	The number of maximum Solar PV modules in series 能串联在一起的组件的最大数量
<b>V<sub>oc</sub></b>	The open circuit voltage of each module (see product label or datasheet) STC 条件下组件的开路电压（可以查看组件的标签或者规格书）
<b>β</b>	Temperature coefficient of open circuit voltage of the module (refer to datasheet) 组件的开路电压的温度系数（请参考组件的规格书）
<b>T<sub>min</sub></b>	The lowest ambient temperature at installation site 组件安装地的最低环境温度

If the modules are allowed to be installed in parallel electrically, each module (or series string of modules so connected) shall be provided with the maximum series fuse as specified. For applications requiring high currents, several photovoltaic modules can be connected in parallel; the total current is equal to the sum of individual currents, each module (or series string of modules so connected) shall be provided with the maximum series fuse as specified. The recommended number of module in parallel is only one. The modules' electrical performance in a system is the same. When connected in series, all modules must have the same amperage. When connected in parallel, the modules must all have the same voltage. Connect the quantity of modules that match the voltage specifications of the devices used in the system. The modules must not be connected together to create a voltage that is higher than the permitted system voltage.

如果允许组件并联安装，则每个组件(或串联的组件串)应按规定配置最大串联保险丝。对于需要大电流的应用，多个光伏组件可以并联；总电流等于各电流之和，每个组件(或串联的组件串)应按规定配置最大串联保险丝。推荐的组件并联数只有一个。组件在系统中的电气性能是相同的。串联时，所有组件必须具有相同的安培数。当并联时，所有组件必须具有相同的电压。连接组件的数量与系统中使用的设备的电压规格相匹配。组件不能连接在一起以产生高于允许的系统电压的电压。

Product can be irreparably damaged if an array string is connected in reverse polarity to another. Always verify the voltage and polarity of each individual string before making a parallel connection. If you measure a reversed polarity or a difference of more than 10V between strings then check the string configuration before making the connection.

如果一组阵列以相反极性连接到另一个，则会对产品造成无法修复的损坏。在进行并联之前，请务必确认各列的电压和极性。如果测量发现各列之间的极性相反或电压差值大于10V，则在连接之前检查其结构配置。

Before wiring the module, ensure that the contact points are corrosion resistant, clean and dry; If a string of modules is reversed, irreparable damage can be caused.

在组件布线之前，请确保接触点是耐腐蚀、清洁和干燥的；如果一个组件串正负极反接，可能会造成无法弥补的损害。

Each Grand Sunergy PV module has two PV cables which can withstand 85°C temperature and they are sunlight resistant(UV). The cross-sectional area of the cable is 4mm<sup>2</sup> or 12AWG, and the external diameter is 5mm~7mm. The minimum bending radius of the cables must be 43mm. Any cable damage caused by bending too much or cable management system is not covered under Grand Sunergy's warranty. Each wire end has a plug and play connector with a temperature limit of 105 ° C. All other cables used to connect the direct current system shall have similar (or higher) specifications, and should have the suitable insulation ability which can suffer the possible maximum system V<sub>oc</sub> (as defined in TUV 2PFG1169 or EN50618 (H1Z2Z2-K)). Grand Sunergy requires all cables and electrical connections to comply with the electrical regulations of the countries where the PV system is installed.

国晟科技的每块太阳能光伏组件都有两根可以承受85°C的温度以及抗日照的标准PV电线电缆，其导电芯截面积为4mm<sup>2</sup>或12AWG，导电线的外部直径为5mm~7mm。电缆的最小弯曲半径应为43mm。因过度弯曲或电缆管理系统造成的损坏不包括在国晟的保修范围内。每根导线端点都带有即插即用的连接器，连接器的温度限制为105°C。用于连接直流系统的所有其他电缆应具有相似（或更高）规格。同时具备适当的绝缘性能以便承受可能的最大系统开路电压（如 TUV 2PFG1169 或者 EN50618（H1Z2Z2-K）批准）。国晟要求所有接线和电气连接符合该光伏系统安装地各国电工法规的规定。

Under normal conditions, a PV module is likely to experience conditions that produce higher current and/or voltage than reported at standard test conditions. Accordingly, the values of I<sub>sc</sub> and V<sub>oc</sub> . marked on this PV module should be multiplied by a factor of 1.25 at least when determining component voltage ratings, conductor current ratings, and size of controls (e.g. inverter) connected to the PV output.

在正常情况下，组件可能会遇到产生比标准测试条件下更高的电流或电压的情况。因此当确定组件额定电压、导体额定电流和连接到PV输出的控制装置(如逆变器)的尺寸时，标记在此组件上的I<sub>sc</sub>和V<sub>oc</sub>的值最低应乘以1.25的系数。

When selecting a cable, the minimum current-carrying capacity of the cable can be calculated by the following formula.

在选择电缆时，电缆的最小载流容量可以通过下面这个公式来计算。

Minimum current-carrying capacity of the cable =  $1.25 \cdot I_{sc} \cdot N_p$

电缆最小载流容量 =  $1.25 \cdot I_{sc} \cdot N_p$

$I_{sc}$ : short-circuit current of PV module (unit: A)

$I_{sc}$ : 光伏组件的短路电流 (单位: A)

$N_p$ : the number of modules in parallel or module strings

$N_p$ : 并联的组件数量或者组件串数量

Photovoltaic (electric) systems operate automatically and require very little day-to-day supervision. The solar array generates DC electricity whenever light falls on it similarly the inverter automatically turns ON as soon as there is sufficient energy from the solar array to efficiently convert this into grid quality AC power.

光伏(电力)系统是自动运行的, 几乎不需要日常监督。太阳能阵列产生直流电, 每当光落在它类似的逆变器自动打开, 一旦有足够的能源从太阳能阵列有效地转换成电网质量的交流电源。

Caution:

注意:

The module is rated to operate at potentially lethal DC voltages which have the potential can cause severe electrical shock, arcing and fire hazards. Whilst some solar modules, manufactured by Grand Sunergy, are certified to operate up to 1500V always check the module label to confirm the actual rating of your product before making connections.

该组件额定工作在潜在的致命直流电压下, 有可能导致严重的触电、电弧和火灾危险。国晟科技生产的一些太阳能组件通过了运行1500V的认证, 在连接之前, 请始终检查组件标签, 以确认您的产品的实际额定值。

Always use a suitably rated isolator (DC switch) to interrupt the current flow before disconnecting the connectors.

在断开连接器之前, 始终使用一个适当额定的隔离器(直流开关)来中断电流

To ensure proper system operation the correct cable connection polarity (Figures 1 & 2) should be observed when connecting the modules to each other or to a load, such as inverter, a battery etc. If modules were not connected correctly, the bypass diodes could be destroyed. PV modules can be wired in series to increase voltage. A series connection is made when the wire from the positive terminal of one module is connected to the negative terminal of the next module. A parallel connection is made when the wire from the positive terminal of one module is connected to the positive terminal on the next module. Do not connect Fuse in Combiner Box with two or more strings in parallel connection.

为了确保系统正常运行, 在连接组件或连接负载(如变频器、电池等)时, 应观察确保电缆的极性连接正确。如果组件连接不正确, 旁路二极管可能会损坏。光伏组件可以串联接线以增加电压。串联连接是将接线从一个组件的正极端子连接到下一个组件的负极端子上。光伏组件可以并联连接以增加电流。并联连接是将接线从一个组件的正极端子连接到下一个组件的正极端子上。禁止将组串接入无防返装置的汇流箱或组串式逆变器中。

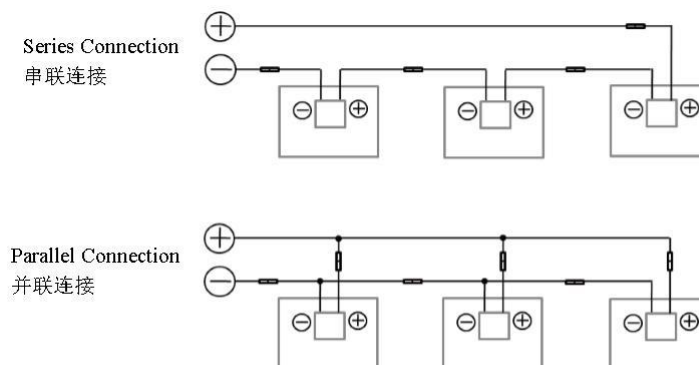


Fig 1



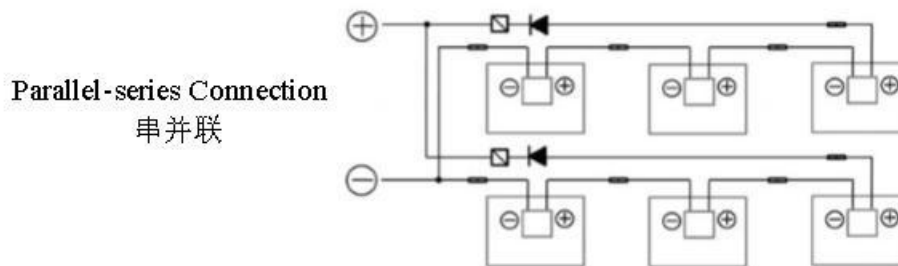


Fig 2

The number of modules in series and in parallel shall be designed reasonably according to the system configuration.

组件串联并联数量，需根据系统配置合理设计。

To clear or trim excess cables and Grand Sunergy recommends that all cables be placed in proper pipework and away from standing water.

清理或整理多余的电缆，国晟科技建议所有电缆应布设在适当的管道中且远离易积水的地方。

Grand Sunergy recommends using lightning protection devices which are complied with local laws and electrical regulations.

国晟科技建议使用符合当地法律法规要求和电工规定的防雷保护装置。

All the above instructions must be followed to meet Grand Sunergy warranty conditions.

须遵守上述所有说明以满足国晟科技保修条件。

### 3、Bypass secondary 旁路二极管

If PV module part by shadow block, which can lead to reverse voltage related to Solar cells, PV modules in other unaffected battery string or other PV modules in the system and current will force through keep out part of the power loss and heat affected cell. When the PV module is connected in parallel with the bypass diode, the current in the system will flow directly through the diode, so as to bypass the blocked part of the PV module and minimize the heating degree and power consumption of the PV module.

如果光伏组件某个部分受阴影阻挡，这会导致相关的太阳能电池形成反向电压，太阳能光伏组件中其他未受影响的电池串或系统中其他太阳能光伏组件的电流将会强行通过遮挡部分而产生电量损失并给受影响的电池片加热。当在太阳能光伏组件中并联旁路二极管后，系统中的电流将直接从二极管流过，从而旁路掉太阳能光伏组件中被遮挡的部分，把太阳能光伏组件发热程度和电能损耗降到最低。

Each module has three diodes. Please do not try to open the junction box to replace the diode, or even when the diode problem, please do this work by professionals.

每个光伏组件都在接线盒中装有3个旁路二极管。请不要尝试打开接线盒更换二极管，甚至是当二极管出现问题的时候，这些工作请由专业人士完成。

### 4、FUSING 熔断保险丝

When fuses are fitted they should be rated for the maximum DC voltage and connected in each, non-grounded pole of the array (i.e. if the system is not grounded then fuses should be connected in both the positive and negative poles).

安装熔断器时，它们的额定电压应为最大直流电压，并连接在阵列的每个非接地极上（即，如果系统未接地，则熔断器应连接在正极和负极上）。

The maximum rating of a fuse connected in series with an array string is typically 25A or 30A, but the actual module specific rating can be found on the product label and in the product datasheet.

与阵列串串联的保险丝的最大额定值通常为 25A 或 30A，但实际的组件特定额定值可在产品标签和产品数据表中找到。

This fuse rating value also corresponds to the maximum reverse current that a module can withstand (when one string is shaded then the other parallel strings of modules will be loaded by the shaded string and current will flow) and therefore impacts the number of strings in parallel. Parallel module configurations: fuse rating/IsC.

该熔断器额定值也对应于一个组件可以承受的最大反向电流（当一串被遮挡时，其他并联的组件串将由被遮挡的串加载并

且电流会流动)，因此会影响并联的串数。并联组件配置：保险丝额定值/IsC。

## 5、Grounding 接地

All PV module frames and mounting brackets must be properly grounded in accordance with the applicable national electrical code.

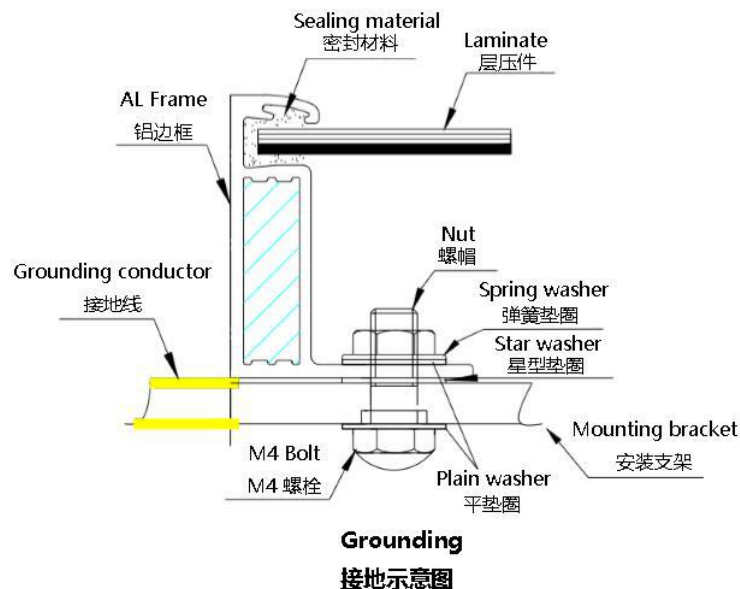
所有的太阳能光伏组件边框和安装支架都必须按照相应的《国家电气规程》正确的接地。

Correct grounding is achieved by continuously connecting the PV module frame and all metal modules together using the appropriate grounding conductor. The grounding wire may be copper, copper alloy or other materials that can be used as conductors and meet the requirements of the national electrical code. It is recommended to use the copper wire (4-14mm<sup>2</sup> or AWG 6-12) as the grounding wire. The signal "⏏" can be found at the grounding hole position. The ground wire must also be connected to ground through a suitable ground electrode. The tight connection of all the joint point should be ensured.

通过使用合适的接地导体将光伏组件边框和所有金属构件连续连接在一起以实现正确接地。接地线可以是铜、铜合金或是其他可以作为导线并且符合相应的《国家电气规程》要求的用作导体的材料。推荐使用4~14mm<sup>2</sup>的铜导线（AWG 6-12）作为接地导线。组件的接地孔位置有接地标识“⏏”。接地线也必须通过合适的接地电极连接到大地。所有的导电连接点必须牢固连接。

On a grounding hole with a diameter of  $\phi 4$  mm, use a separate grounding wire and related accessories to connect the aluminum frame of the Solar PV module and connect the grounding wire to the ground. The grounding uses the M4\*12mm bolts and M4 nuts, star washers and plain washers, this ensures that the modules are firmly grounded. You can find the corresponding product drawing in module datasheet to know the detailed number, size and position of the grounding holes. The torque applied to ground fixation is 4N·m~8N·m.

接地孔设计在光伏组件背面的铝合金边框上，直径为4mm，使用单独的接地线和相关配件连接太阳能光伏组件的铝合金边框并将接地线连接到大地，建议使用M4\*12mm的接地螺栓并配套有M4的螺母，星型垫圈及平垫圈，这样能确保组件被牢靠接地。您可以在组件产品手册上找到相应的产品图纸，来了解详细的产品接地孔数量，尺寸和位置。接地固定应用扭力矩为4N·m~8N·m。



When grounding, each module can be grounded directly or in series or in parallel. If you choose the latter two options, it is recommended that the maximum number of modules connected in parallel should not exceed four, and in series should not exceed eight.

接地时，可以每块组件直接接地，也可以在组件串联或者并联后接地。在采取后者方式接地时，建议并联的最大数量不应超过四块组件，串联的最大数量不超过八块组件。

In addition to use the grounding hole, you can also choose the following grounding ways:

除了使用接地孔来进行接地外，您也可以选用以下方式来进行接地：

- (1) Grounding by unused mounting holes 使用未被使用的安装孔接地
- (2) Other professional grounding devices 其他专用接地装置

The electrical contact points of all the above grounding methods should penetrate the anodized film of the aluminum

frame. PV modules can be grounded by other grounding devices, which must be reliable and certified. The manufacturer's requirements should be followed.

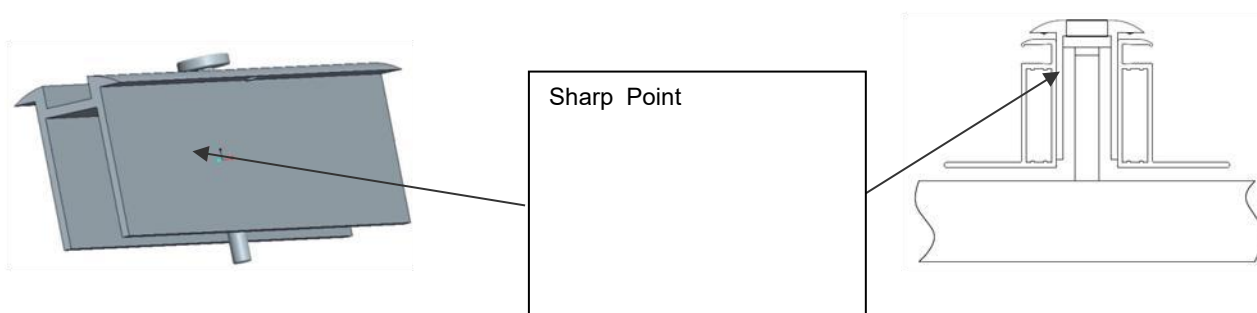
不管采用哪一种接地方式，所有光伏组件铝合金边框的接地电接触点都需要穿透铝边框的阳极氧化涂层。在使用专用接地装置等其他第三方的接地装置接地时，需要确保这些接地装置是可靠的，并且通过专业认证的产品，在安装时需要遵守接地装置生产商的使用规定。

Grand Sunergy recommends using the following grounding ways:

**国晟科技建议采用以下接地方式：**

a) Using Schleiter for grounding. Connecting modules to the support structure according to the picture below. (Grounding accessories need pass the UL467 standard test.)

a) 使用施莱特接地。根据下图将组件连接到支撑结构。（接地配件需通过UL467标准测试。）



Recommended torque is 20.5Nm

建议扭矩为20.5Nm

For more information, please contact the supplier Grand Sunergy (<https://www.grandsunergy.com/>)

更多信息请联系供应商国晟科技 (<https://www.grandsunergy.com/>)

b)The traditional way of grounding (Grounding accessories need pass the UL467 standard test and UL E34440/E6207 test.)

传统接地方式（接地配件需通过UL467标准测试和UL E34440/E6207测试。）为充分接地，接地硬件应穿透框架的阳极氧化层。推荐10-12 AWG裸铜接地线。

For fully grounding, grounding hardware should penetrate the anodic oxidation layer of frame.Recommended 10-12 AWG bare copper grounding wire.

## 6、FIRE SAFETY 防火安全

Before installing components, consult local laws and regulations and comply with the building fire protection requirements. The single-glass component of the Seraph is UL Type 1 or 2 or IEC Class C, and the dual-glass component is UL Type 29 or IEC Class C. When installing the roof, the roof must be covered with a layer of fire-resistant material suitable for this grade and adequate ventilation should be provided between the backplane and the mounting surface. Different roof structure and installation will affect the fire safety performance of the building. If not properly installed, it may cause a fire. To ensure a fire rating on the roof, the minimum distance between the frame of the assembly and the roof surface is 10 cm. Use appropriate components such as fuses, circuit breakers, and ground connectors according to local regulations. Do not use components if exposed flammable gases are present nearby

安装组件前请咨询当地的法律法规，遵守其中关于建筑防火性要求。根据对应认证标准，国晟的单玻组件防火等级为UL type 1or2 或 IEC Class C，双玻组件的防火等级为UL type 29 或 IEC Class C。在屋顶安装的时候，屋顶上必须要覆盖有一层适用于该等级的防火材料，并且保证背板和安装面之间充分的通风。屋顶的结构和安装方式不同会影响建筑的防火安全性能。如果安装不恰当，可能会酿成火灾。为了保证在屋顶的防火等级，组件边框与屋顶表面的最小距离为 10 厘米。请根据当地的法规要求使用恰当的组件配件如保险丝，断路器，接地连接器。如果附近出现暴露的可燃性气体，请勿使用组件

## 7、MODULE MAINTENANCE 组件维护

In order to ensure the long-term using of the installed PV system and maximize the Power output performance of the modules, the installed PV modules need to be inspected and maintained regularly. The inspection and maintenance of modules in the PV array shall be carried out by personnel who have received professional PV system maintenance training and obtained relevant qualifications and authorization.

为了保证所安装的光伏系统能够长期使用，并且最大化组件的功率输出表现，需要定期对所安装的光伏组件进行检查和维护。光伏方阵中组件的检查和维修需要受过专业光伏系统维护培训并获得相关资质和授权的人员来进行。

### 7.1、PANEL VISUAL INSPECTION AND REPLACEMENT 组件外观检查和替换

The modules in a PV array should be regularly checked for damage. Factors such as glass breakage, cable breakage, junction box damage and the terminals cannot be connected well may lead to function and safety problems. In the case of a damaged module, replace it with the same type of module. Do not touch live parts of cables and connectors. Use appropriate safety equipment (insulated tools, insulating gloves, etc.) when handling modules. Refer to the appropriate Product Installation Manual for installation and disassembly of module.

应定期检查光伏方阵中组件是否有坏，例如玻璃破裂、线缆破损、接线盒损坏、接线端子无法良好连接等因素导致组件发生功能性和安全性故障，须更换相同类型组件。不许触碰电缆和连接器的带电部位。搬运组件时应使用适当的安全防护装置（绝缘工具、绝缘手套等）。组件的安装和拆卸请参阅产品安装手册。

Check the electrical, grounding and mechanical connections every 6 months to ensure they are clean and safe, free from damage or rust. Check that all string fuses in each non/earthed pole are operating. Check that the mounting parts are tight. Check all cables and make sure that the connectors are securely. PV modules frames and bracket should be well mechanically connected.

建议每6个月检查一次电气、接地和机械连接件，确保其清洁安全，无损坏或生锈；检查每个非接地极中的所有阵列熔丝是否正常工作；检查安装部件是否已拧紧；检查所有电缆并确保接头牢固拧紧。使用金属边框的光伏组件，边框和支架应结合良好。

Check whether there is any foreign body on the surface of the PV modules and whether there is any shielding. Trim any vegetation which may shade the PV array, thus impacting performance.

检查光伏组件表面是否有异物，是否有遮挡。除去一切可能遮蔽光伏方阵从而影响其性能的植被。

When repairing PV modules, cover the surface of PV modules with opaque material to prevent electric shock. Exposure of PV modules to sunlight will generate high voltages, this is dangerous. Please pay attention to safety when maintenance and it must be done by professionals.

修理太阳能光伏组件时请用不透明的材料覆盖在太阳能光伏组件表面以防止产生电击。太阳能光伏组件暴露在阳光下会产生高电压，维修时请注意安全，维修必须有专业人员进行。

Wear cut resistant gloves and other personal protective equipment required for the particular installation. Isolate the impacted array string to prevent current flow before attempting to remove the module. Disconnect the connectors of the affected module using the related disconnect tool provided by suppliers. Replace the damaged module with a new functional module of the same type.

进行特殊安装时需要穿戴防切割手套和其他防护装备。在尝试移除组件之前，一定要将受影响的阵列隔离以防止电流产生。用供应商提供的相关断开工具去断开受影响组件的连接器。使用相同类型的新组件更换损坏的组件。

In a system using a battery, blocking diodes are typically placed between the battery and the PV module output to prevent battery discharge at night.

在使用电池的系统中，阻塞二极管通常放置在电池和光伏组件输出装置之间以防止夜间电池放电。

Diodes that are used as blocking diodes must have a:

用作阻塞二极管的二极管必须具备：

a) Rated Average Forward Current [  $I_{F(AV)}$  ] above the maximum system current at the highest module operating temperature.

a) 额定平均正向电流 [  $I_{F(AV)}$  ] 在组件最高工作温度下高于最大系统电流。

b) Rated Repetitive Peak Reverse Voltage [  $V_{RRM}$  ] above the maximum system voltage [  $V_{max}$  ] at the lowest module operating temperature (IEC:  $V_{max}=1500V$  ; )

b) 组件最低工作温度下额定重复峰值反向电压 [  $V_{RRM}$  ] 高于最大系统电压 [  $V_{max}$  ] (IEC:  $V_{max}=1500V$  ; )

When the irradiance is no less than  $200W/m^2$ , if the terminal voltage is more than 5% different than the rated value, it illustrates the connection of the modules is not good.

在辐照度不低于 $200W/m^2$ 的情况下，如果终端的电压与额定值相差5%以上，说明组件连接不好。

Comply with maintenance instructions for all modules used in the PV system, such as brackets, charging rectifiers, inverters, batteries, lightning protection systems, etc.

必须遵守光伏系统使用的所有部件，如支架、充电整流器、逆变器、蓄电池、防雷系统等的维护说明。

**Warning:** The warning signs on the PV modules must not be lost. Any electrical maintenance must shut down the PV system firstly. Improper system maintenance may cause fatal dangers such as electric shock and burning. Observe the safety precautions listed earlier in this Manual.

**警告：**光伏组件上的带电警告标识不得丢失。任何电气的维护都必须首先关闭光伏系统，不合适的系统维护可能导致电击和燃烧等致命的危险。请注意本手册前面列出的安全注意事项。

## 7.2、CONNECTOR AND CABLE INSPECTION 连接器和线缆检查

It's recommended to implement the following preventive maintenance every 6 months:

推荐每六个月进行一次以下的预防性维护：

(1) Check the sealing gels of the junction box for any damage.

检查接线盒的密封胶，确保没有裂纹或缝隙；

(2) Examine the PV module(s) for signs of deterioration. Check all wiring for possible rodent damage, weathering and that all connections are tight and corrosion free. Check electrical leakage to ground.

检查光伏组件的老化迹象。包括可能的啮齿动物破坏、气候老化，以及所有连接器是否连接紧密、有无腐蚀现象。检查组件是否接地良好。

(3) Inspect all cables to verify that connections are tight, the cables are protected from direct sunlight and sited away from areas of water collection.

检查所有电缆以验证其连接是否牢固；避免电缆受阳光直射且使其远离积水区域。

(4) Check the torque of terminal bolts and the general condition of wiring. Also, check that mounting hardware is properly torqued. Loose connections will result in damage to the array.

检查端子螺栓的扭矩和接线的各方面情况。此外，检查安装的硬件是否紧固到位。连接松动会导致阵列损坏。

## 7.3、CLEANING 清洗

Dust accumulation on the glass surface of the module will reduce its power output and may cause hot spots. So the surface of PV modules should be kept clean. Maintenance work should be performed at least once six months or frequently.

组件的功率输出和入射光强有关，灰尘堆积在组件的玻璃表面会影响入射光强，降低组件能量输出。所以光伏组件表面应保持清洁，清洗工作应至少半年一次或根据污染程度来进行更频繁的清洗。

**Warning:** It should be carried out by trained personnel. Workers should wear PPE, such as goggles, electric insulation gloves and safety shoes. The gloves should withstand DC voltages of no less than 2000V.

**警告：**组件的清洗工作应由受过训练的人员进行，工作人员应穿戴防护用品，如护目镜、绝缘手套、安全鞋等，手套应能承受不低于2000V的直流工作电压。

Use dry or wet soft cloths, sponges, etc. to clean the modules during the cleaning process, but do not put any modules directly into the water, do not use corrosive solvents and do not wipe the PV modules with hard objects. When the pressure water is used, the water pressure on the glass surface of the module must not exceed 700 KPa. The module must not be subjected to additional external force. If there is greasy dirt and other substances on the surface of the PV module which are difficult to clean, conventional household glass cleaning agents can be used; Do not use the alkaline and strong acid solvents. If necessary, use isopropyl alcohol (IPA) or other solution according to the safety instructions to clean and ensure that no solution flows into the gap between the edge of the module and the module frame.

应使用干燥或潮湿的柔软洁净的布料和海绵擦拭光伏组件，严禁使用腐蚀性溶剂或用硬物擦拭组件。在采用压力水流清洗时，组件玻璃表面的水压不得超过700KPa，组件严禁承受额外的外力；但不要直接将任何组件放入水中。光伏组件表面有油污等难清洁物质，可使用常规家用玻璃清洗剂；注意不能使用碱性及强酸性溶剂。如有必要，可以按照安全指示使用异丙醇（IPA）或其他合适溶剂清洗，并确保溶剂没有流入组件边缘和组件框架之间的间隙。

Clean PV modules when the irradiance is below 200W/m<sup>2</sup>. When cleaning the modules, use a soft cloth together with a mild detergent and clean water. Take care to avoid severe thermal shocks which might damage the module by cleaning modules with water which has a similar temperature to the modules being cleaned. For example, do not use cold water to clean the module when the temperature of it is high during the day, otherwise there will be the risk of module damage.

应在辐照度低于200W/m<sup>2</sup>的情况下清洁光伏组件。清洁组件时，应使用软布和温和的清洁剂以及清水。清洁组件时应保证水与组件之间的温差不大，以注意避免出现严重的可能损坏组件的热冲击。比如不在一天中光伏组件温度较高的时候使用冷水清洗，以防损坏光伏组件。

It is forbidden to clean PV modules under the weather conditions of wind more than 4 grades, heavy rain or heavy snow.

严禁在风力大于4级、大雨或大雪的气象条件下清洗光伏组件。

When cleaning PV modules, Do not step on the modules; Do not spray water on the backside of the module or the cables; keep the connectors clean and dry; prevent fire and electrical shock from occurring; Do not use as steam cleaner.

光伏组件清洁工作中，严禁踩踏组件、严禁流水溅射至组件背面和电缆，严禁清洁组件背面，要保证连接头的清洁和干燥，防止电击和火灾危险；严禁使用蒸汽清洁器。

The back surface of the module normally does not need to be cleaned but, in the event this is deemed necessary, avoid the use of any sharp projects that might damage the penetrating the substrate material.

组件的后表面通常不需要清洁；但在认为确实有必要对其进行清洗时，应避免使用可能引起损坏或穿透基底材料的一切尖锐物体。

When cleaning the back surface of the module, take care to avoid penetrating the substrate material. Modules that are mounted flat (0° tilt angle) should be cleaned more often, as they will NOT "self-clean" as effectively as modules mounted at a 10° tilt or greater.

清洁组件的背面时，注意避免清洗液渗到材料底层。应稍微频繁地清洁水平安装的组件（0°倾斜角），因为这些组件不会像以10°倾斜角或更大倾斜角安装的组件那样具有“自清洁”功能。

Do not scrape or grind stains off surfaces while PV modules are dry, as this can cause minor scratches on the surface.

组件干燥的情况下不要在表面将污渍刮掉或者磨掉，因为这样会在表面引起细小的刮伤。

### **Water requirements when cleaning:**

#### **清洗时对水质的要求：**

- (1) PH: 5~7;  
PH值:5~7
- (2) Chloride or salt content: 0 - 3000 mg/L  
氯化物或盐分含量：0~3000 mg/L;
- (3) Turbidity: 0-30 NTU  
浑浊度：0~30 NTU;
- (4) Conductivity: 1500~3000  $\mu\text{s}/\text{cm}$   
电导率：1500~3000  $\mu\text{s}/\text{cm}$ ;
- (5) Total dissolved solids:  $\leq 1000$  mg/L  
总溶解固体： $\leq 1000$  mg/L;
- (6) Water hardness: 0-40 mg/L  
水硬度：0~40 mg/L;
- (7) Non-alkaline water must be used, and softened water can be used when conditions permitted.  
必须采用非碱性水，具备条件时应使用软化水。

### **7.3.1 MODULE INSPECTION AFTER CLEANING 清洗后组件检查**

- (1) Ensure that the module under visual inspection is clean, bright and free of stains;  
目视组件整体外观是否清洁、明亮、无污渍；
- (2) Spot check to verify whether there is soot deposit on the module surface;  
抽样检查组件表面是否有积灰存在；
- (3) Check to whether there are visible scratches on the surface of the module or not;  
检查组件表面有无明显的刮伤痕迹；
- (4) Check whether there is no man-made cracks on the module surface or not;  
组件表面有无人为造成的破裂现象；
- (5) Check whether the module support structure is leaning or bent or not;  
清洗后组件支架有无倾斜和弯曲现象；
- (6) Check whether the connectors of the module are detached or not;

清洗后组件接线端子是否有松开或脱落现象；

(7) After cleaning, fill out the PV module cleaning record.

需要完成清洗后文字记录。

### 7.3.2 TROUBLESHOOTING 故障排查

If the PV system does not work properly, please inform your installer immediately. It is recommended to perform a preventive inspection every six months, please don't change any modules of the modules. If electrical or mechanical properties are required for inspection or maintenance, qualified professionals should be advised to avoid any electric shock or loss of life.

如果安装后，光伏系统无法正常工作，请立即通知安装商。建议每6个月执行一次预防性检查，不要擅自更换组件的元部件，如果需要进行电性能或机械性能的检查和维护，需要让具有资质的，并且受过专业培训的专业人员进行操作，以免发生触电或人员伤亡。

**WARNING:** For any electrical maintenance, the PV system must first be shut down. Improper maintenance can cause lethal electric shock and/or burns.

**警告:**对于任何电气维护，光伏系统必须首先关闭。维护不当会引起致命的触电和/或烧伤。



国晟科技  
Grand Sunergy Tech

诚信 / 担当 / 系天下  
—  
利他 / 共享 / 赢未来



国晟世安科技股份有限公司  
Guosheng Shian Technology Co., Ltd.

网址: [www.grandsunergy.com](http://www.grandsunergy.com)

邮箱: [sales@grandsunergy.com](mailto:sales@grandsunergy.com)